

**SC-IW (IN-WALL)
SUBWOOFER**

SUBCONTRACTOR™ SERIES

**INSTALLATION
MANUAL**



IMPORTANT SAFETY INSTRUCTIONS



Caution

To reduce the risk of electric shock, do not remove cover (or back). No user-serviceable parts inside. Refer servicing to qualified service personnel.

The lightning flash with arrowhead symbol is intended to alert the user to the presence of uninsulated "dangerous voltage" within the product's enclosure that may be of sufficient magnitude to constitute a risk of electric shock to persons.

The exclamation point symbol is intended to alert the user to the presence of important operating and maintenance (servicing) instructions in the literature accompanying the subwoofer.

1. **Read Instructions** — All safety and operating instructions should be read before the product is operated.
2. **Retain Instructions** — The safety and operating instructions should be retained for future reference.
3. **Heed Warnings** — All warnings on the product and in the operating instructions should be adhered to.
4. **Follow Instructions** — All operating and use instructions should be followed.
5. **Water and Moisture** — The product should not be used near water — for example, near a bathtub, washbowl, kitchen sink, laundry tub, in a wet basement, near a swimming pool or the like.
6. **Carts and Stands** — The product should be used only with a cart or stand recommended by the manufacturer.
7. **Wall or Ceiling Mounting** — The product should be mounted to a wall or ceiling only as recommended by the manufacturer.
8. **Ventilation** — The product should be situated so that its location or position does not interfere with its proper ventilation. For example, the product should not be situated on a bed, sofa, rug, or similar surface that may block the ventilation openings; or placed in a built-in installation such as a bookcase or cabinet that may impede the flow of air through the ventilation openings.
9. **Heat** — The product should be situated away from heat sources such as radiators, heat registers, stoves, or other products that produce heat.
10. **Power Sources** — The product should be connected to a power supply only of the type described in the operating instructions or as marked on the product.
11. **Grounding or Polarization** — This product may be equipped with a polarized alternating-current line plug (a plug having one blade wider than the other). This plug will fit into the power outlet only one way. This is a safety feature. If you are unable to insert the plug fully into the outlet, try reversing the plug. If the plug should still fail to fit, contact your electrician to replace your obsolete outlet. Do not defeat the safety purpose of the polarized plug.
12. **Power-Cord Protection** — Power-supply cords should be routed so that they are not likely to be walked on or pinched by items placed upon or against them, paying particular attention to cords at plugs, convenience receptacles, and the point at which they exit from the product.
13. **Cleaning** — The product should be cleaned only as recommended by the manufacturer.
14. **Nonuse Periods** — The power cord of the product should be unplugged from the outlet when left unused for a long period of time.
15. **Object and Liquid Entry** — Care should be taken so that objects do not fall and liquids are not spilled onto the enclosure.
16. **Damage Requiring Service** — The product should be serviced by qualified service personnel when:
 - a. The power-supply cord or plug has been damaged.
 - b. Objects have fallen or liquid has been spilled into the product.
 - c. The product has been exposed to rain.
 - d. The product does not appear to operate normally or exhibits a marked change in performance.
 - e. The product has been dropped or damaged.
17. **Servicing** — The user should not attempt to service the product beyond what is described in the operating instructions. All other servicing should be referred to qualified service personnel.
18. **Lightning** — For added protection for the product during a lightning storm or when it is left unattended and unused for long periods of time, unplug it from the wall outlet.
19. **Overloading** — Do not overload wall outlets, extension cords or integral convenience receptacles as this can result in a risk of fire or electric shock.

CAUTION: To prevent electrical shock, match wide blade of plug to wide slot, fully inserted.

CONSIGNE DE SÉCURITÉ IMPORTANTES



ATTENTION

Risque d'électrocution
Ne pas ouvrir



Attention

Afin d'éviter tout risque d'électrocution, ne pas enlever le couvercle (ou la partie arrière). Aucune pièce interne ne peut être manipulée par l'utilisateur. Confiez l'entretien à un personnel qualifié.

Le symbole de l'éclair avec la flèche sert à avertir l'utilisateur de la présence d'une « tension dangereuse » non isolée dans l'enceinte du produit; cette tension peut être assez élevée pour provoquer un danger d'électrocution pour les personnes.

Le symbole du point d'exclamation sert à avertir l'utilisateur de la présence de consignes importantes de fonctionnement et de maintenance (entretien) dans la documentation accompagnant le caisson d'extrêmes graves.

1. **Lire les consignes** — Lisez toutes les consignes de sécurité et de fonctionnement avant de faire fonctionner ce produit.
2. **Conserver les consignes** — Conservez les consignes de fonctionnement pour un usage éventuel.
3. **Tenir compte des avertissements** — Il faut se conformer à tous les avertissements et à toutes les consignes de fonctionnement qui se trouvent sur le produit.
4. **Suivre les consignes** — Il faut se conformer à toutes les consignes de fonctionnement et d'utilisation.
5. **Eau et humidité** — Le produit doit pas être utilisé près de l'eau (par exemple, près d'un bain, d'un évier, d'un bac de lessive, dans un sous-sol humide, près d'une piscine, etc.).
6. **Chariots et supports** — Utiliser uniquement le produit avec un chariot ou un support recommandé par le fabricant.
7. **Montage au mur ou au plafond** — Monter uniquement le produit sur un mur ou un plafond de la façon recommandée par le fabricant.
8. **Ventilation** — Le produit doit être situé dans un endroit ou une position qui ne nuit pas à sa ventilation adéquate. Par exemple, ne pas placer le produit sur un lit, un canapé, une moquette ou une surface semblable qui peut bloquer les ouvertures de ventilation; ne pas poser le produit sur un meuble encastré comme une bibliothèque ou un meuble qui peut empêcher l'air de circuler par les ouvertures de ventilation.
9. **Chaleur** — Éloigner le produit des sources de chaleur comme les radiateurs, les registres d'air chaud, les cuisinières ou d'autres produits qui dégagent de la chaleur.
10. **Sources d'électricité** — Le produit doit être raccordé uniquement à une prise d'alimentation d'un type décrit dans les consignes de fonctionnement ou tel que mentionné sur le produit.
11. **Mise à la masse ou polarisation** — Ce produit peut être muni d'une fiche polarisée pour courant alternatif (une fiche comportant une lame plus large que l'autre). Cette fiche ne peut être introduite dans une prise de courant que d'une seule façon. Il s'agit d'un dispositif de sécurité. Si vous n'êtes pas en mesure d'insérer la fiche dans la prise de courant, essayez d'inverser la fiche. Si la fiche ne correspond pas à la prise, consultez un électricien pour faire remplacer la prise défectueuse. Ne pas rendre inopérante la sécurité offerte par la fiche polarisée.
12. **Protection du cordon d'alimentation** — Les cordons d'alimentation doivent être acheminés pour éviter que personne ne marche dessus ou que rien ne puisse être placé sur ou contre eux; il faut faire particulièrement attention aux cordons raccordés à des prises électriques, des prises de service et au point de sortie du produit.
13. **Nettoyage** — Le produit doit être nettoyé selon les recommandations du fabricant.
14. **Périodes de non-utilisation** — Le cordon d'alimentation du produit doit être débranché de la prise de courant lorsqu'il demeure inutilisé pendant une période prolongée.
15. **Infiltration d'objet ou de liquide** — Faire attention à ce qu'aucun objet ne tombe dans le produit ou que des liquides ne s'y infiltrent.
16. **Dommages nécessitant réparation** — Le produit doit être réparé uniquement par du personnel d'entretien qualifié lorsque :
 - a. le cordon d'alimentation ou la fiche a été endommagée;
 - b. des objets sont tombés dans le produit ou du liquide s'y est infiltré;
 - c. le produit a été exposé à la pluie;
 - d. le produit ne semble pas fonctionner normalement ou présente un important changement de performance;
 - e. le produit a été échappé ou endommagé.
17. **Entretien** — L'utilisateur ne doit pas tenter d'effectuer l'entretien du produit au-delà de ce qui est décrit dans les consignes de fonctionnement. Toute autre réparation doit être confiée à du personnel qualifié.
18. **Foudre** — Pour une plus grande protection du produit au cours d'un orage ou lorsqu'il demeure inutilisé pendant une période prolongée, le débrancher de la prise de courant.
19. **Surcharge** — Ne pas surcharger les prises murales, les rallonges ou les prises intégrées car cela peut provoquer un incendie ou un choc électrique.

ATTENTION : ...Afin d'éviter tout choc électrique, introduire à fond la lame la plus large de la fiche dans la borne correspondante.

WICHTIGE SICHERHEITSHINWEISE



VORSICHT
GEFAHR VON STROMSCHLÄGEN
NICHT ÖFFNEN



Vorsicht

Um der Gefahr von Stromschlägen vorzubeugen, das Gehäuse (bzw. die Rückwand) nicht abnehmen. Im Inneren befinden sich keine Teile, die vom Benutzer gewartet werden können. Reparatur- und Wartungsarbeiten nur von entsprechend qualifizierten Kundendiensttechnikern durchführen lassen.

Das Symbol „Blitz mit Pfeilspitze“ soll den Benutzer warnen, dass im Gehäuse des Produkts eine nicht isolierte „gefährliche Spannung“ vorhanden ist, die so hoch sein kann, dass die Gefahr von für Menschen gefährlichen Stromschlägen besteht.

Das Symbol „Ausrufezeichen“ soll den Benutzer auf wichtige Bedienungs- und Wartungshinweise in der Begleitdokumentation des Produkts aufmerksam machen.

1. **Anweisungen durchlesen** — Lesen Sie sämtliche Sicherheits- und Bedienungshinweise, bevor Sie das Produkt in Betrieb nehmen.
2. **Anweisungen aufbewahren** — Bewahren Sie die Sicherheits- und Bedienungshinweise zum späteren Nachschlagen auf.
3. **Warnungen beachten** — Berücksichtigen Sie alle Warnungen auf dem Produkt und in der Bedienungsanleitung.
4. **Anweisungen befolgen** — Folgen Sie allen Bedienungs- und Verwendungshinweisen.
5. **Wasser und Feuchtigkeit** — Verwenden Sie das Produkt nicht in der Nähe von Wasser – z. B. an Badewannen, Wasch- oder Spülbecken, in einem feuchten Keller, am Schwimmbeckenrand o. ä.
6. **Rollwagen und Ständer** — Das Produkt sollte nur mit einem vom Hersteller empfohlenen Wagen oder Stativ verwendet werden.
7. **Wand- oder Deckenmontage** — Eine Wand- oder Deckenmontage des Produkts darf nur gemäß den Herstellerempfehlungen erfolgen.
8. **Belüftung** — Das Produkt muss so positioniert werden, dass am Installationsort eine unbehinderte Luftzirkulation möglich ist. Beispielsweise darf das Produkt nicht auf einem Bett, Sofa oder Teppich oder auf einer ähnlichen Oberfläche aufgestellt werden, die die Belüftungsöffnungen überdecken kann; auch die Aufstellung in einem Bücherregal oder Schrank ist nicht zulässig, wenn dies den Luftstrom durch die Belüftungsöffnungen behindern würde.
9. **Wärme** — Das Produkt darf nicht in der Nähe von Wärmequellen wie Heizkörpern, Heizluftausströmern, Öfen oder weiteren Wärme abstrahlenden Produkten installiert werden.
10. **Stromversorgung** — Das Produkt darf ausschließlich an eine Stromversorgung des Typs angeschlossen werden, der in der Bedienungsanleitung genannt oder auf dem Produkt angegeben ist.
11. **Erdung oder Polung** — Dieses Produkt ist eventuell mit einem gepolten Wechselspannungs-Netzstecker ausgerüstet (bei dem einer der Kontakte breiter ist als der andere). Dieser Stecker passt nur in einer Ausrichtung in die Netzsteckdose. Dies dient zu Ihrer Sicherheit! Wenn sich der Stecker nicht ganz einstecken lässt, versuchen Sie, ihn um 180° zu drehen. Falls der Stecker dann noch immer nicht eingesteckt werden kann, ist die Steckdose veraltet und muss von einem Elektriker ausgetauscht werden. Die Polung des Steckers ist ein Sicherheitsmerkmal und darf keinesfalls durch Manipulationen außer Kraft gesetzt werden!
12. **Schutz des Netzkabels** — Netzkabel müssen so verlegt werden, dass keine Personen darauf treten und dass sie nicht von darauf oder daneben abgestellten Gegenständen gequetscht werden können. Besonders gefährdet sind die Kabel in der Nähe von Steckern und Steckdosen sowie am Gehäuseeintritt in das Produkt.
13. **Reinigung** — Das Produkt darf nur gemäß den Herstellerempfehlungen gereinigt werden.
14. **Nichtbenutzung** — Der Netzstecker des Produkts sollte abgezogen werden, wenn das Gerät längere Zeit nicht verwendet wird.
15. **Eindringen von Gegenständen und Flüssigkeiten** — Achten Sie darauf, dass keine Gegenstände in das Produkt fallen und keine Flüssigkeiten darüber verschüttet werden.
16. **Zu reparierende Schäden** — In den folgenden Fällen muss das Produkt durch den qualifizierten Kundendienst repariert werden:
 - a. Das Netzkabel oder der Netzstecker wurde beschädigt.
 - b. In das Produkt sind Gegenstände gefallen, oder Flüssigkeit wurde darüber verschüttet.
 - c. Das Produkt ist im Regen nass geworden.
 - d. Das Produkt scheint nicht wie gewohnt zu funktionieren oder weist eine deutlich veränderte Leistung auf.
 - e. Das Produkt wurde fallen gelassen oder beschädigt.
17. **Wartung** — Versuchen Sie nicht, Wartungsarbeiten am Produkt durchzuführen, die über den Umfang der in der Bedienungsanleitung beschriebenen Maßnahmen hinausgehen. Alle darüber hinausgehenden Wartungsmaßnahmen dürfen ausschließlich von entsprechend geschulten Fachkräften durchgeführt werden.
18. **Blitzschlag** — Damit das Produkt bei einem Gewitter oder während längerer Abwesenheit und Nichtbenutzung zusätzlich geschützt ist, sollte der Netzstecker in diesen Fällen abgezogen werden.
19. **Überlast** — Wandsteckdosen, Verlängerungskabel oder integrierte Steckdosen nicht überlasten, da dadurch die Gefahr von Bränden oder Stromschlägen entstehen kann.

VORSICHT: ...SCHUTZ DES NETZKABELS: Zur Vermeidung von Stromschlägen muss der breitere Steckerkontakt vollständig in den breiten Schlitz eingeführt werden.

ATTENZIONE!

IMPORTANTI ISTRUZIONI DI SICUREZZA



ATTENZIONE

**PERICOLO DI SCOSSA
ELETTRICA NON APRIRE**



Attenzione

Per ridurre il pericolo di scossa elettrica, non smontare il coperchio o il pannello posteriore. All'interno non ci sono parti riparabili dall'utente. Per le riparazioni, rivolgersi a personale qualificato.

Il simbolo con la freccia forma di fulmine avvisa l'utente della presenza di "tensioni pericolose" all'interno della cassa del prodotto, non isolate e di intensità sufficiente a costituire pericolo di scossa elettrica per le persone.

Il simbolo con il punto esclamativo avvisa l'utente della presenza di importanti istruzioni di uso e manutenzione nella documentazione che accompagna il subwoofer.

1. **Leggere le istruzioni** — Prima di usare il prodotto, leggere tutte le istruzioni di uso e sicurezza.
2. **Conservare le istruzioni** — Conservare le istruzioni di uso e sicurezza per riferimento futuro.
3. **Rispettare le avvertenze** — Osservare tutte le avvertenze presenti sul prodotto e contenute nelle istruzioni per l'uso.
4. **Seguire le istruzioni** — Seguire tutte le istruzioni di uso e funzionamento.
5. **Acqua e umidità** — Il prodotto non deve essere usato in vicinanza di acqua — ad esempio vicino a vasche da bagno, lavandini, lavelli, lavatoi, in seminterrati umidi, vicino a piscine, o altro.
6. **Carrelli e supporti** — Il prodotto deve essere usato solo con un carrello o supporto raccomandato dal produttore.
7. **Montaggio a parete o a soffitto** — Il prodotto deve essere montato su pareti e soffitti solo come raccomandato dal produttore.
8. **Ventilazione** — Il prodotto deve essere posizionato in modo che l'ubicazione non ne impedisca la corretta ventilazione. Ad esempio, il prodotto non deve essere collocato su letti, divani, tappetini o superfici simili che possono ostruire le aperture di ventilazione, e neppure incassato in scaffali o armadietti che possano impedire il flusso dell'aria attraverso le aperture di ventilazione.
9. **Calore** — Il prodotto deve essere collocato lontano da sorgenti di calore come radiatori, diffusori di aria calda, stufe, o altri prodotti che generano calore.
10. **Sorgenti di alimentazione** — Il prodotto deve essere collegato solo a una sorgente di alimentazione del tipo descritto nelle istruzioni per l'uso o indicata sul prodotto stesso.
11. **Collegamento a terra o polarizzazione** — Questo prodotto può essere dotato di una spina polarizzata per corrente alternata (una spina con una lamella più grande dell'altra). Questa spina si può inserire nella presa di corrente in un solo modo. Si tratta di una caratteristica di sicurezza. Se non si riesce a inserire a fondo la spina nella presa, provare rovesciando la spina. Se ancora non si riesce a inserire la spina, rivolgersi a un elettricista o sostituire la presa obsoleta. Non disattivare questa caratteristica di sicurezza della spina polarizzata.
12. **Protezione dei cavetti di alimentazione** — Disporre i cavetti di alimentazione in modo che non possano essere calpestati o schiacciati da oggetti collocati sopra o contro di essi, facendo particolare attenzione vicino alle spine, alle prese, e nei punti in cui i cavetti escono dal prodotto.
13. **Pulizia** — Pulire il prodotto solo come raccomandato dal fabbricante.
14. **Periodi di non uso** — Quando non si usa il prodotto per un lungo periodo di tempo, staccare dalla presa elettrica il cavetto di alimentazione.
15. **Penetrazione di liquidi e oggetti** — Evitare con attenzione la caduta di oggetti e la penetrazione di liquidi all'interno del prodotto.
16. **Danni che richiedono manutenzione** — Il prodotto deve essere riparato da personale tecnico qualificato in caso di:
 - a. danni al cavetto o alla spina di alimentazione;
 - b. caduta di oggetti e la penetrazione di liquidi all'interno del prodotto;
 - c. esposizione del prodotto alla pioggia;
 - d. funzionamento anomalo o notevole cambiamento nelle prestazioni del prodotto;
 - e. caduta o danni del prodotto.
17. **Manutenzione** — L'utente non deve provare a intervenire sul prodotto oltre quanto descritto nelle istruzioni per l'uso. Per tutti gli altri interventi, rivolgersi a personale tecnico qualificato.
18. **Scariche elettriche** — Per maggiore protezione del prodotto durante i temporali o quando lo si lascia incustodito o inutilizzato lunghi periodi di tempo, staccare la spina dalla presa di alimentazione.
19. **Sovraccarico** — Non sovraccaricare prese elettriche di alimentazione, prolunghe o prese di alimentazione integrate nei prodotti poiché questo comporta pericolo di incendio o scosse elettriche.

ATTENZIONE ...PROTEZIONE DEL CAVETTO DI ALIMENTAZIONE: per evitare scosse elettriche, inserire a fondo la lamella larga della spina nella fessura larga della presa.

TABLE OF CONTENTS

Product Overview	1
- Driver Technology	1
- Cabinet Technology	1
Installation Overview	3
New Construction Installation - Standard Grille	4
New Construction Installation - Designer Grille	15
Retro-Fit Installation - Designer Grille	25
Retro-Fit Installation - Standard Grille	38
Other Velodyne Subwoofer Products	53

PRODUCT OVERVIEW

The SC-IW (In-Wall) subwoofer can be installed in a variety of locations and positions in any given installation. Although this product is extremely versatile and flexible in its uses, it has been specifically designed for two major applications - New Construction Installations and Retro-Fit Installations in structures made of traditional 2x4 studs with 16 inch spacing, on-center.

This document provides the detailed process for properly installing the SC-IW into a wall. The SC-IW is designed to be powered by the SC-1250 subwoofer amplifier. For maximum performance, it is strongly recommended that only the SC-1250 be used to power the SC-IW. The user's manual for the SC-1250 subwoofer amplifier provides the details on connectivity and proper configuration of the SC-IW after installation.

Driver Technology

The SC-IW subwoofer utilizes new and innovative patent-pending driver technology that has been created specifically for the custom installation market. The SC-IW driver was specially designed to maximize in-wall subwoofer performance while significantly reducing wall vibration. The driver uses "dual tandem spider design" along with a propriety neodymium motor structure providing an extremely long-throw driver capable of producing very high sound pressure levels. Below is a cross section of the SC-IW driver.

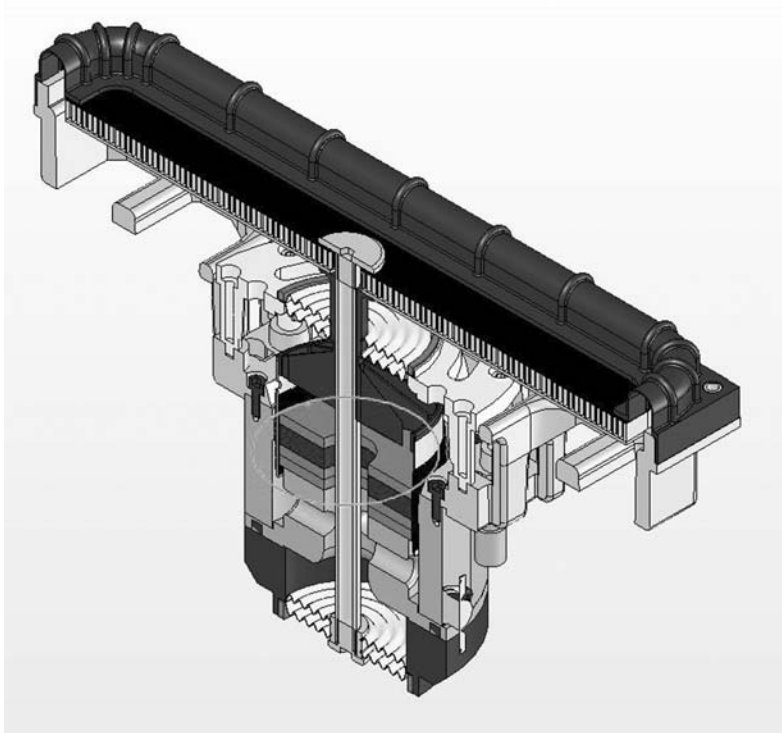

Cabinet Technology

Complimenting the cutting edge technology in the SC-IW driver is the cabinet, again specially designed for in-wall installations. The SC-IW cabinet wall utilizes a propriety multilayer "sandwich" material consisting of two 1.0 mm aluminum plates surrounding 2.5 mm of medium density fiberboard (MDF) which is laminated under high pressure to create an extremely rigid cabinet design that has the density and performance of traditional high end cabinets utilizing 3/4 or 1 inch MDF.

The SC-IW consists of two cabinets — the “driver module” and the “back box.” (a.k.a. the “Enclosure”). Unlike other in-wall products where a back box may be optional, the SC-IW requires both enclosures, unaltered, for every installation. In new construction situations, the back box is installed first (for example, at the framing or rough out stage), and the driver module is installed later in the trim out stage. In retrofit situations both boxes are typically installed together.

The driver module assembly is shown below. It uses a unique bracing system in that the driver acts as the "internal bracing structure" for the speaker enclosure.

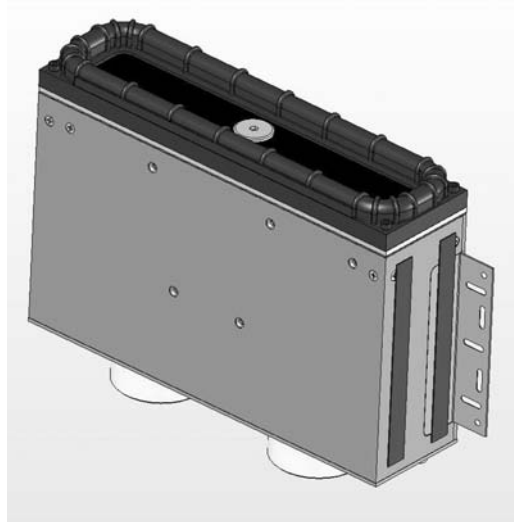

The in-wall back box contains internal bracing to minimize cabinet flex and wall vibration.

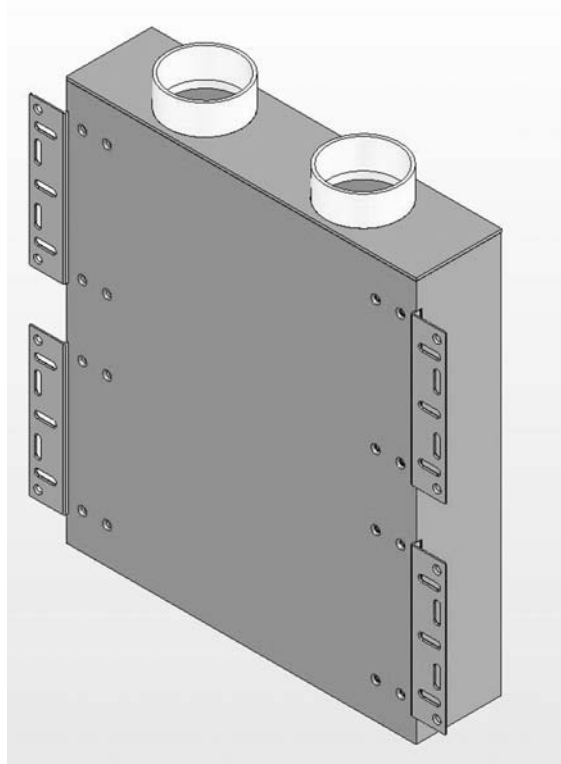

The driver module and the back box are connected through two rubber conduits, sealed with supplied hose clamps. This linking system provides the installer the flexibility to either install the two boxes together in the wall or separately prior to installation.

The SC-IW comes in two completely separate cartons — the SC-IWBB (Back Box) and the SC-IWDVR (Driver).

Parts included with the SC-IWBB rough install kit:

- In-wall back box - Qty 1
- Mudring for "retro fit" installation - Qty 1
- Installation manual - Qty 1
- Installation hardware

Parts included with the SC-IWDVR driver module:

- SC-IW driver module - Qty 1
- Clamp ring - Qty 2
- Standard grille - Qty 1
- Designer grille - Qty 1
- Hardware
- Installation manual - Qty 1

INSTALLATION OVERVIEW

You must first decide how the SC-IW is to be installed — whether new or retrofit installation, and whether you are using the standard or designer grille. Remember that in all cases the grille can be painted to match the room’s décor.

Consider the following information when deciding how the SC-IW will be installed.

CONSTRUCTION	NEW	RETROFIT
Standard Grille	<p>Benefits:</p> <ul style="list-style-type: none"> • Allows pre-installation of the back box at minimal risk and expense • Provides easiest servicing for the driver • No risk to the subwoofer during drywall/paint/finish processes <p>See page 4 for a description of this installation</p>	<p>Benefits:</p> <p>Provides easiest servicing for the driver</p> <p>See page 38 for a description of this installation</p>
Designer Grille	<p>Benefits:</p> <ul style="list-style-type: none"> • Provides the smallest grille available <p>Considerations:</p> <ul style="list-style-type: none"> • Must install both back box and driver cabinet at frame out stage — higher risk of theft or damage to the subwoofer • Difficult to service driver as drywall must be removed to remove driver module <p>See page 15 for a description of this installation</p>	<p>Benefits:</p> <p>Provides the smallest grille available</p> <p>See page 25 for a description of this installation</p>

NEW CONSTRUCTION INSTALLATION – STANDARD GRILLE

Note: This installation process assumes that the installer has access to the open framed 2x4 studded wall with 16 inch spacing. In the event that the stud spacing is larger, an additional 2x4 or other spacer can be used to fill the space between the SC-IW back box and the neighboring stud.

Step 1 - Install Mudring

Unpack the first carton (SC-IWBB) and place the contents on the floor. Remove the mudring from the packaging. At this time the decision needs to be made about which direction the woofer will fire (up or down) and therefore where the grille will be located on the wall. Typically the woofer will fire downwards and the grille will be located near the floor. (Remember to consider baseboards and other trim work that might be used on the house in this case.) Once you have decided where to place the grille, staple the mudring to the studs as shown in figure 1.

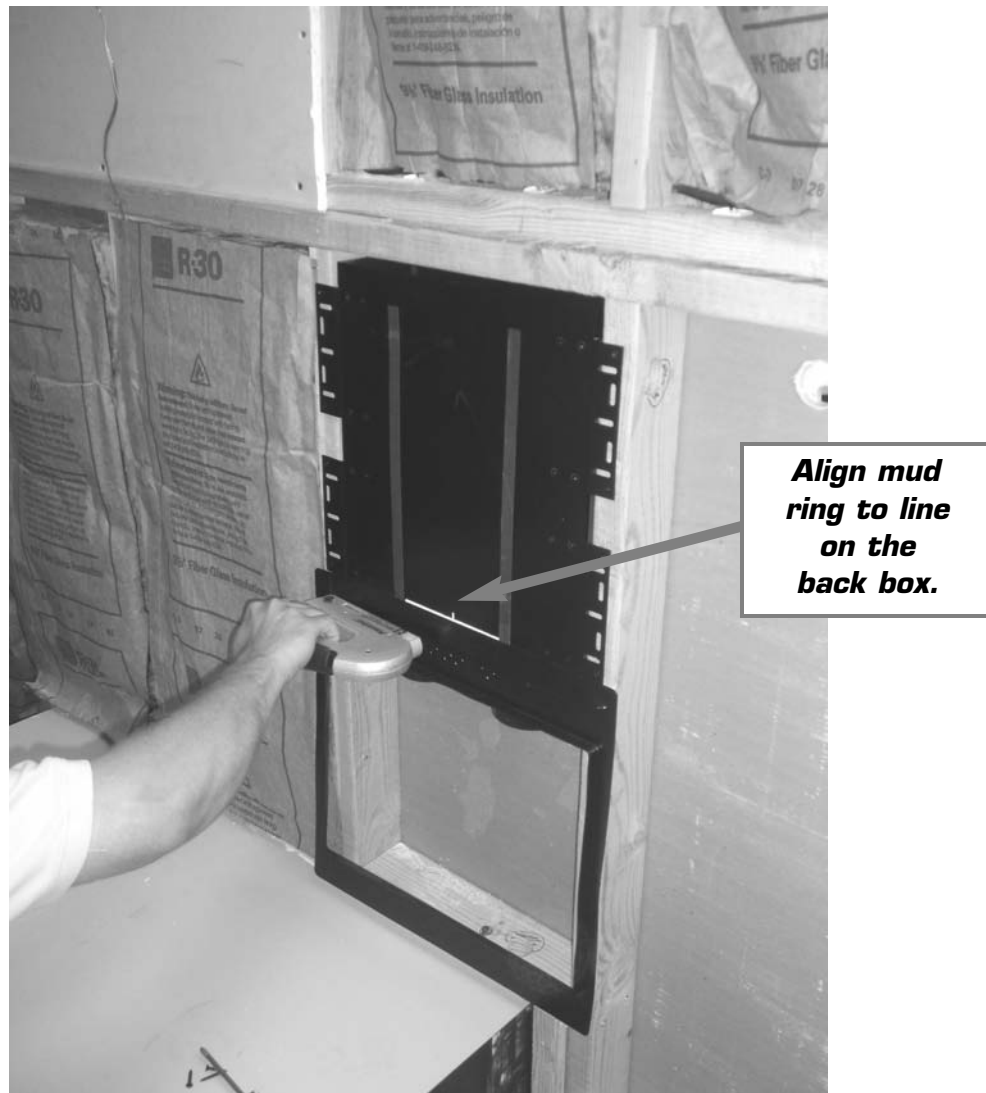

Figure 1: Install Mudring - The back box is used for reference position only — it is installed in the next step.

Step 2 - Install Back Box

Once the mudring is stapled into place, the back box should be installed using eight of the phillips drive flat head screws included in the package. When installing the back box, the mudring should be aligned to the white line on the cabinet. Once the mudring and the back box are aligned, install the back box as shown.



Figure 2: Install Back Box

Step 3 - Route Wire

Route the wire from the location where the electronics gear is located to where the SC-IW will be. There is "extra space" between the studs and the back box in the event that the wire has to pass along the side of the back box to the driver module.



Figure 3: Route Wire

Step 4 - Cover Rubber Couplings

If the installation is not going to be finished right away, Velodyne recommends "taping" or otherwise "covering" the two connecting tubes to prevent paint, drywall and/or foreign objects from entering the back box.

Step 5 - Finish Wall

The wall can now be finished in a traditional fashion utilizing the appropriate drywall thickness, standard texturing and finishing methods. Be sure to advise the "finishing" contractors that they are to drywall up to the edge of the mudring, as the mudring is the place holder for the installation of the driver module and standard grille.



Figure 4: Finish Wall

Note: Steps 6 through 14 presume that you have obtained and are ready to install the SC-IWDVR (In-Wall Driver Module).

Step 6 - Verify Drywall was Properly Installed

Once the wall is finished, the installer must revisit the installation site and verify that the contractors have properly used the mudring as their guide leaving an opening that is approximately 16 1/2" x 13 1/4".

Step 7 - Remove Mudring

At this point, the mudring can be removed. It should be easily removed by "pulling it through" the drywall opening. After it is removed, discard.



Figure 5: Remove Mudring

Step 8 - Place Clamp Rings on Driver Module

Remove the two clamp rings from the packaging and place a clamp ring onto each of the bottom edges of the tubes.

Note: The position of the clamp ring is critical. Make sure that the screw section of the ring is on either side of the tube and not on the front or the back. Please see picture below.

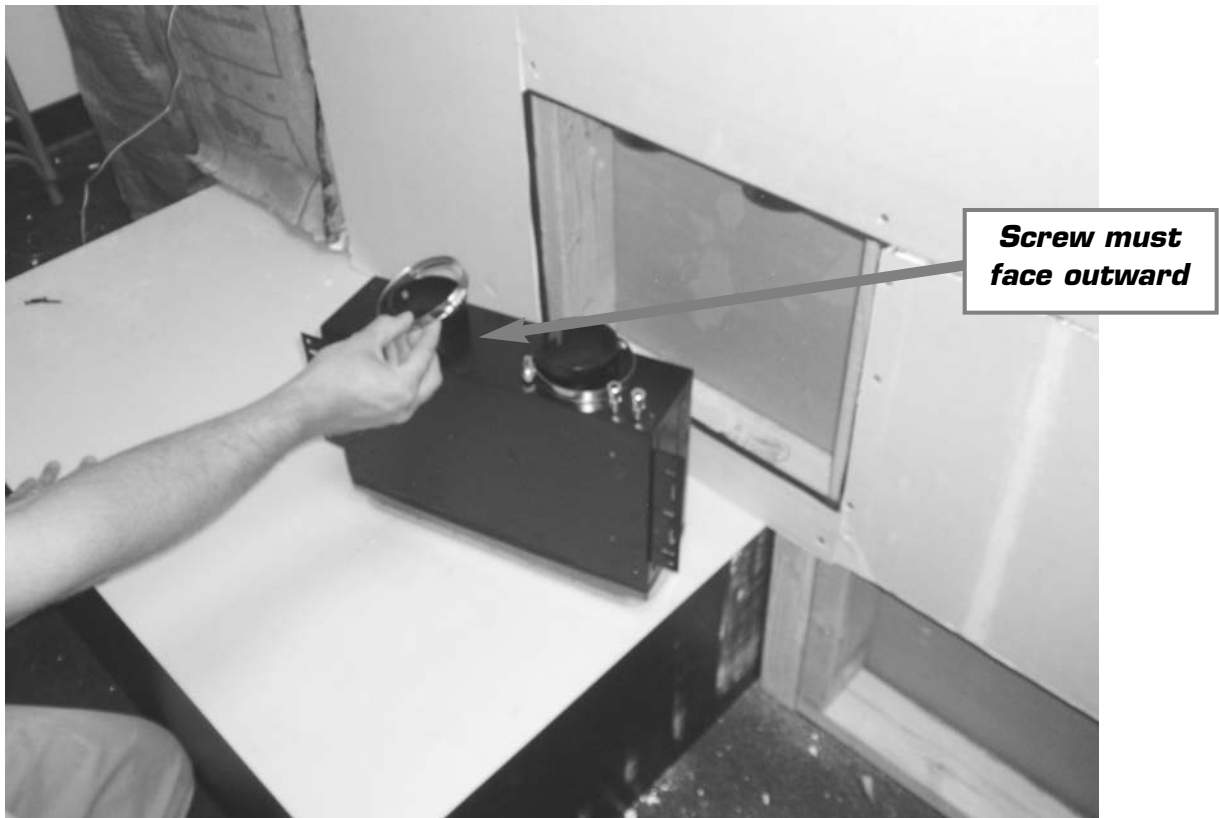

Figure 6: Clamp Ring Placement

Step 9 - Install Driver Module

Insert the driver module assembly through the opening left in the wall by the mudring and slide the plastic tubes onto the two connection tubes. The connection tubes should slide all the way down onto the surface of the driver module assembly. Once the tubes are flush with the driver module, firmly tighten the two clamp rings to seal the rubber coupling to the plastic tube.

Note: The silicon rubber tubes should slide over the tubes protruding from the driver module and the clamp rings should slide over the silicon rubber tubes.



Figure 7: Driver Module Installation

Note: It is critical that a good air seal be achieved between the back box and the driver module. Be sure to properly tighten all clamps. Test the seal by listening to the connection with test audio material after the install is complete.

Step 10 - Remove Metal Grille

Obtain the standard grille with integrated scoop and remove the metal grille insert, as shown, in the picture below.



Figure 8: Metal Grille Insert Removal

Note: The grille can be painted to match the décor. The supplied paint mask can be used to paint the grille frame while the metal grille insert can be painted separately.

Step 11 - Install Grille Frame

Install the plastic grille onto the driver module using the four included machine screws. The grille hardware should easily be installed into the side of the cabinet. Tighten using the supplied allen wrench.



Figure 9: Grille Frame Installation

Step 12 - Secure Grille

Install two pan head phillips screws (provided) into standard grille into bottom left and bottom right holes.

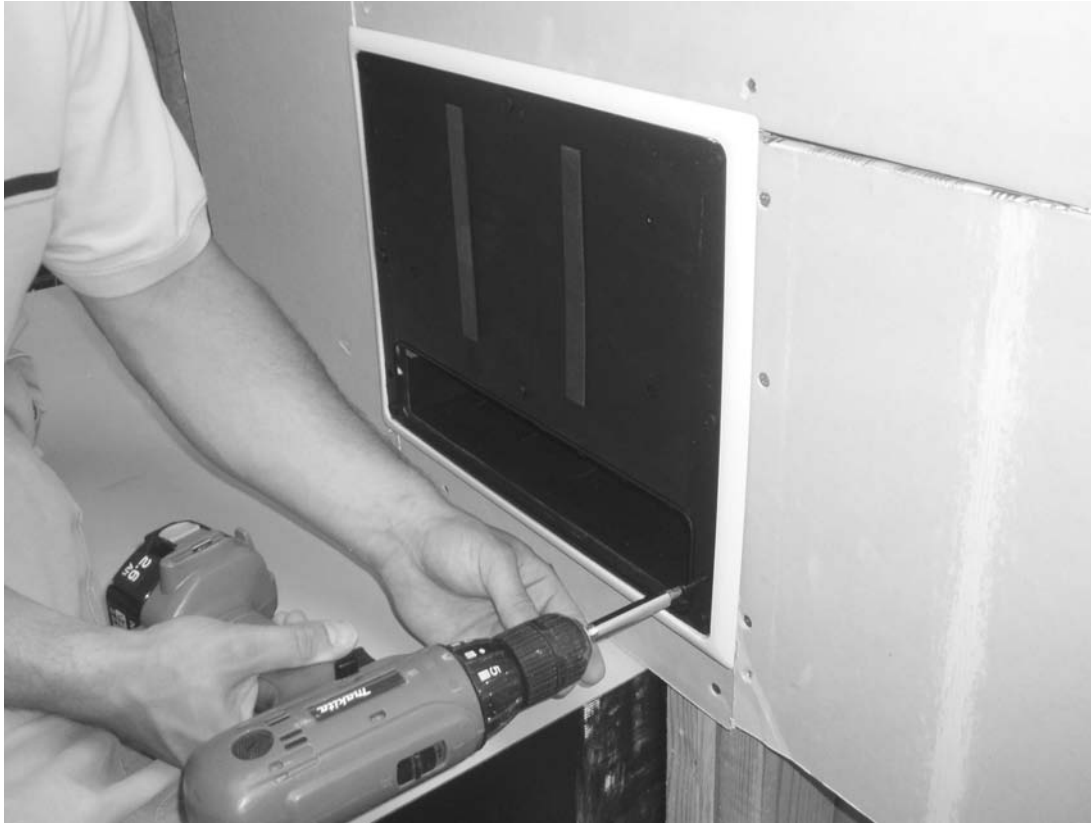

Figure 10: Secure Grille

Step 13 - Install Metal Grille Insert

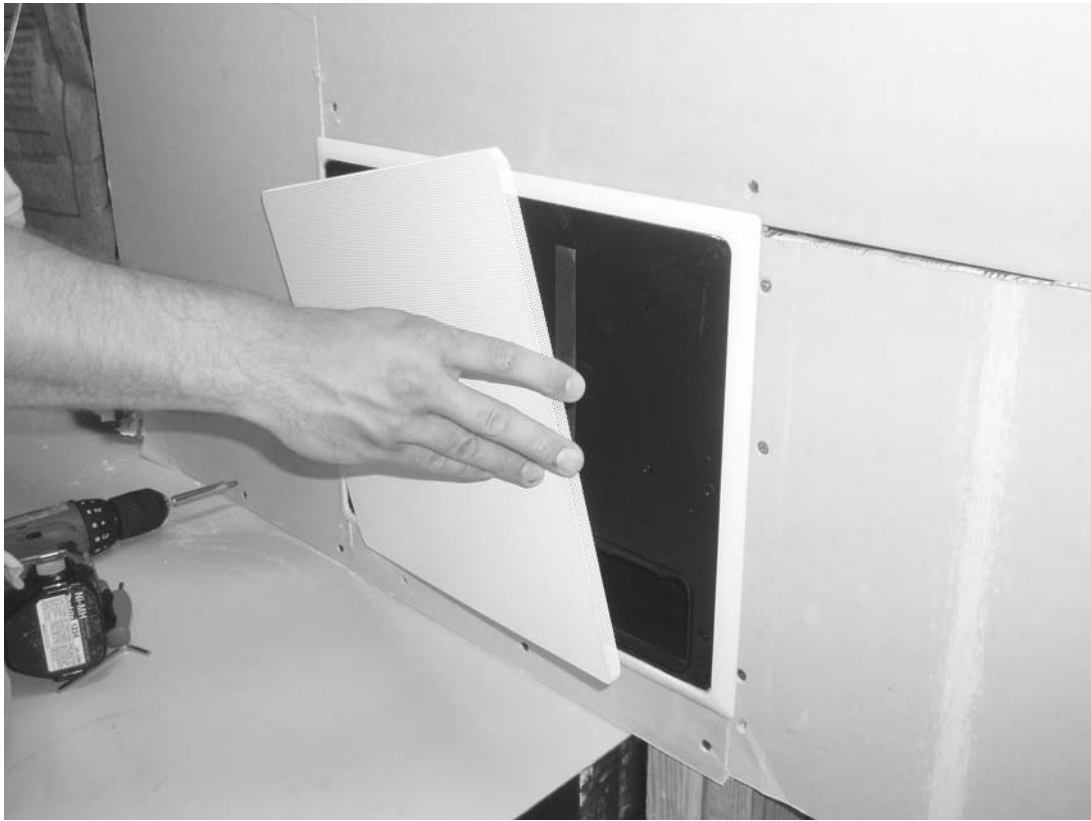

Figure 11: Metal Grille Insert Installation

Step 14 - Installation Complete

The installation is complete. Test the installation with bass audio material and check for buzzes, rattles, and air leaks and address accordingly.



Figure 12: Completed Installation

NEW CONSTRUCTION INSTALLATION – DESIGNER GRILLE

Note: This installation process assumes that the installer has access to the open framed 2x4 studded wall with 16 inch spacing. (In the event that the stud spacing is larger, an additional 2x4 or other spacer can be used to fill the space between the SC-IW back box and the neighboring stud.)

Step 1 - Assemble Cabinet and Driver Modules Together

Remove both the back box and driver modules from the packaging and place them on a clean surface. Place the back box with the two silicon rubber tubes facing upward. Remove the two clamp rings from the packaging and place them over the tubes.



Figures 13a and 13b: Cabinet and Driver Module Assembly

Note: Leave the paint cover on the driver to prevent damage during the installation, painting and finishing process.

Step 2 - Mark Installation Location

Measure from the bottom (or top if the SC-IW is to fire upwards) of the designer grille's lowest (or highest) position 6 3/8" up along the stud and mark the stud in this location. This location will determine the bottom edge of the bracket on the driver module.

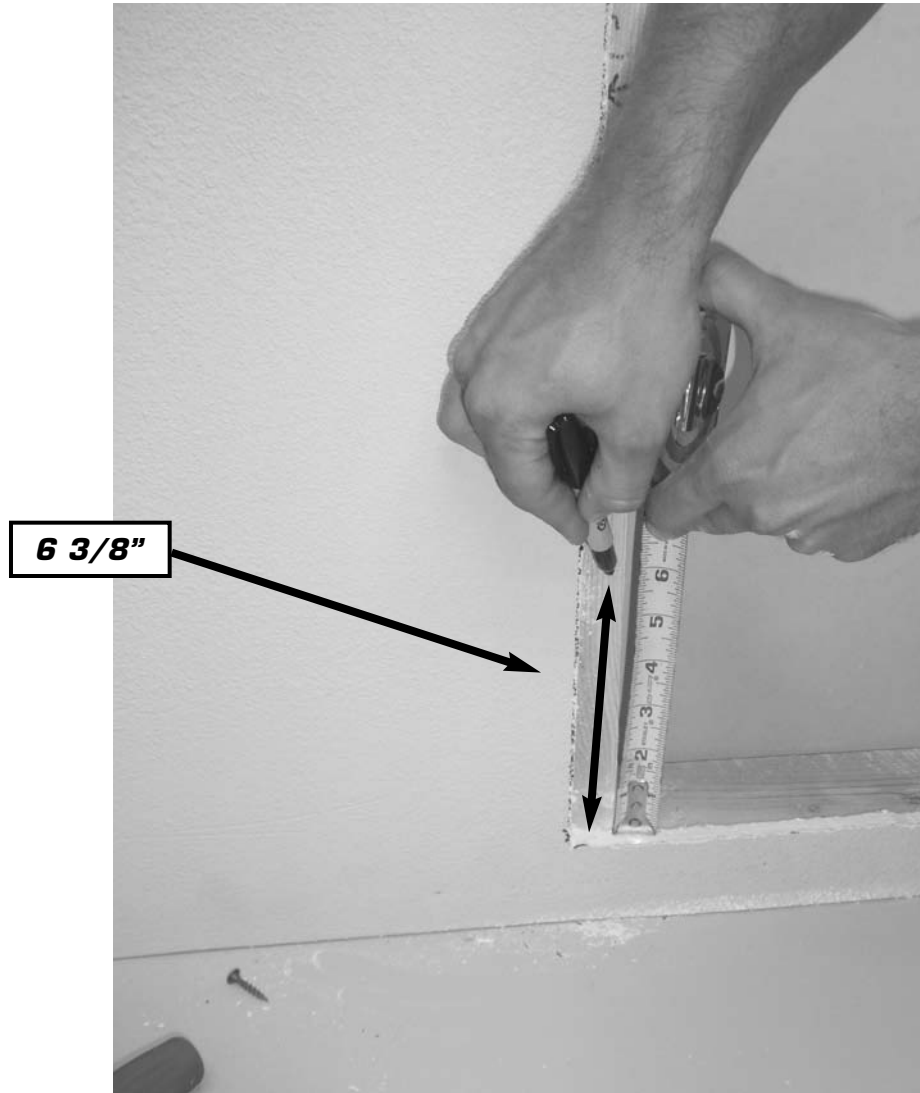

Figure 14: Mark Installation Location

Step 3 - Route Wire

Route the wire from the location where the electronics gear is located to where the SC-IW will be. There is "extra space" between the studs and the back box in the event that the wire has to pass along the side of the back box to the driver module.



Figure 15: Route Wire

Step 4 - Secure Subwoofer to Wall

After the location has been determined, securely fasten the subwoofer to the studs. Velodyne provides 12 screws for this purpose.



Figure 16: Secure Subwoofer

Step 5 - Connect Speaker Wire to Subwoofer

Connect the previously routed speaker wire to the subwoofer taking care to match the positive wire to the red terminal and the negative wire to the black terminal. The spring loaded binding post will hold and secure the wire in place.



Figure 17: Speaker Wire Installation

Step 6 - Install Filler Panel

Velodyne provides an MDF filler panel to fill the distance between the driver module and the drywall. This filler panel also acts as a guide for the standard grille. The filler panel easily installs using the four flat head screws and included allen wrench. Be sure to orientate the filler panel as shown such that the tapered edge faces way from the driver.

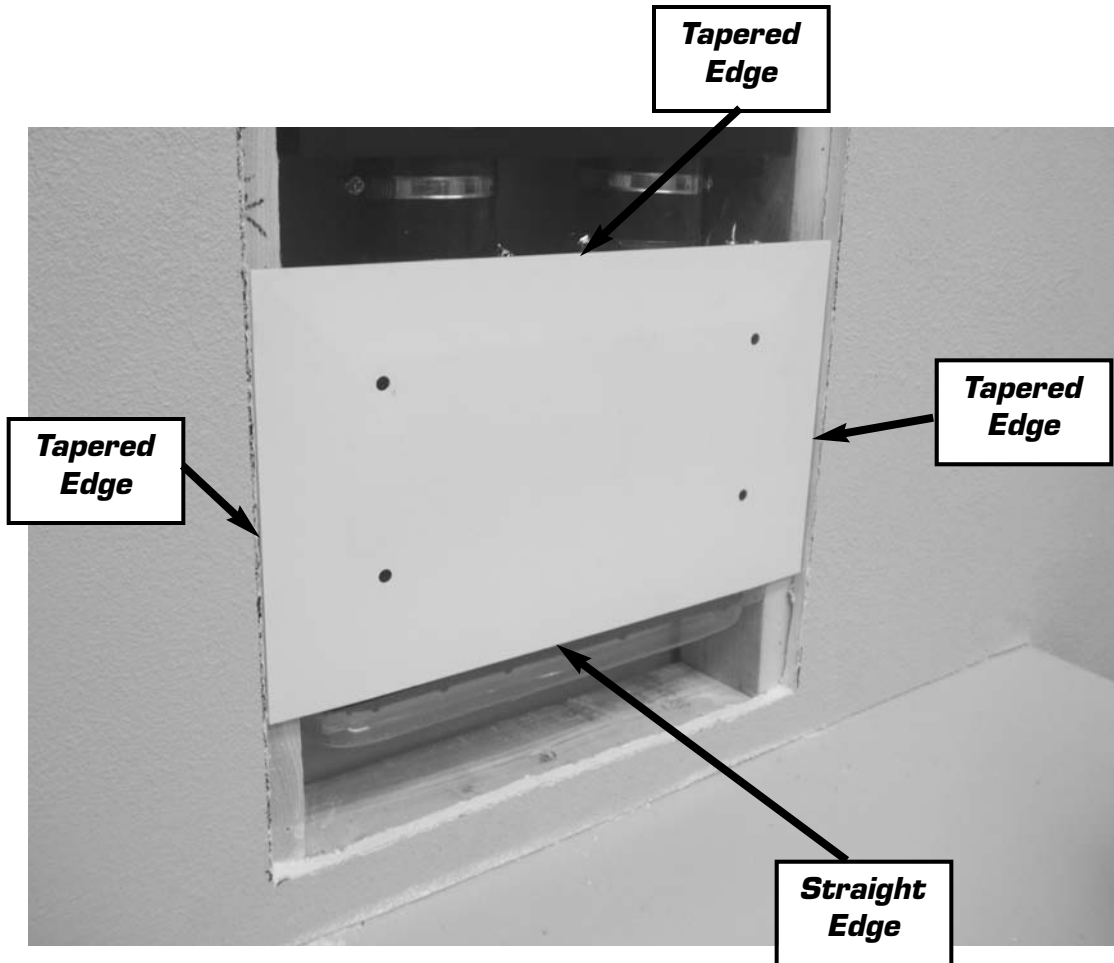

Figure 18: Filler Panel Installation

Step 7 - Install Template Place Holder

Cut out the part of the installation template that outlines the designer grille. Affix the template to the studs at the bottom of the filler panel as shown.



Figure 19: Template Place Holder Installation

Step 8 - Finish Wall

The wall can now be finished in a traditional fashion utilizing the appropriate drywall thickness, standard texturing and finishing methods. Be sure to advise the "finishing" contractors that they are to drywall up to the edge of the template, as the template is the place holder for the installation of the designer template grille.



Figure 20: Finish Wall

Step 9 - Verify Drywall was Properly Installed

Once the wall is finished, the installer must revisit the installation site and verify that the contractors have properly used the mudring as their a guide leaving an opening that is approximately 17 1/2" x 4 1/2".

Step 10 - Install Designer Grille

Remove metal grille insert from the plastic grille and insert into opening into the wall. The grille should then be affixed to the studs using the four included phillips drive pan head screws.

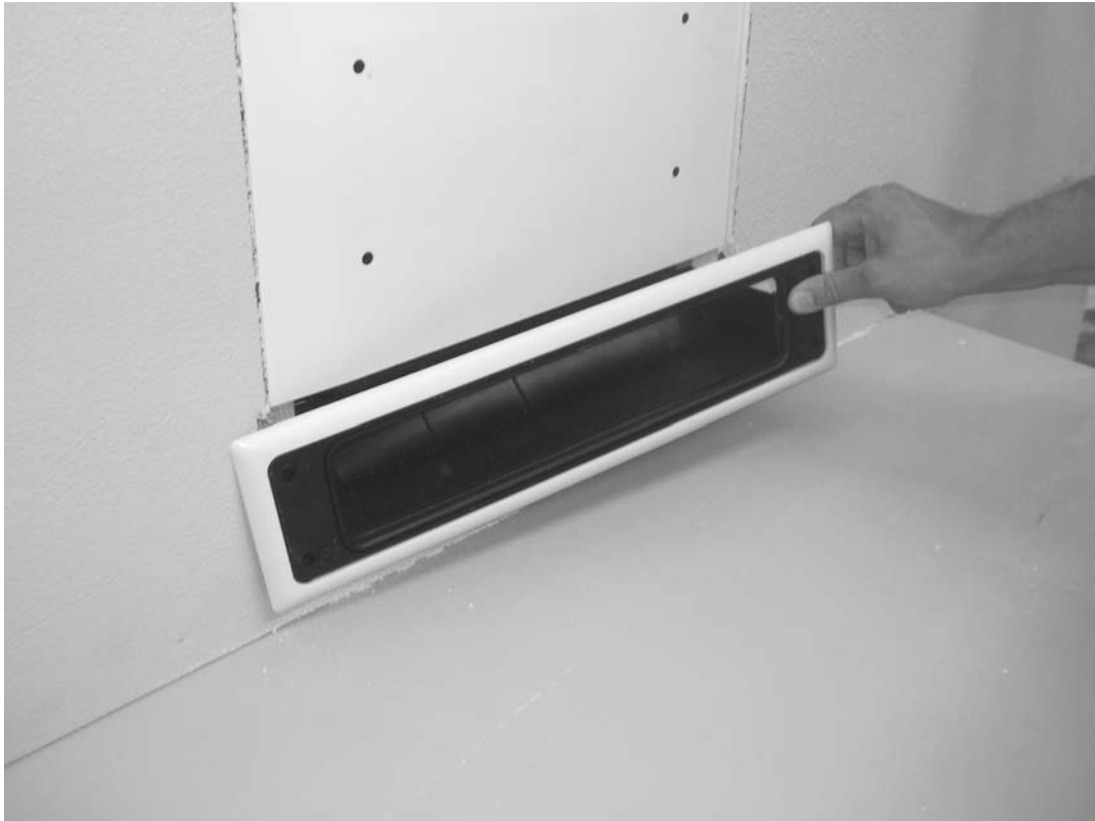

Figures 21a and 21b: Designer Grille Installation



Step 11 - Install Metal Insert into Plastic Grille Frame



Figure 22: Metal Insert Installation

Step 12 - Finished Grille



Figure 23: Finished Grille Installation

RETRO-FIT INSTALLATION WITH DESIGNER GRILLE

Step 1 - Decide on Subwoofer Orientation and Grille Location

The first decision for a retrofit installation is which way the subwoofer will face (up or down), and therefore where the designer grille will be located on the wall (near the floor or ceiling). Once the location is decided, locate the 2x4 studs, spaced 16 inches on center. After the general area of the studs is located, determine the exact location of the studs as detailed in the picture below. There are many methods to do this. Shown is the use of a “drywall saw” used horizontally to find the edge of each stud.



Figure 24: Subwoofer Orientation and Grille Location

Step 2 - Cut Out Drywall Per Template

Once the studs have been located, place the supplied designer grille template on the wall. After the template is secured to the wall with either staples or tape, score the drywall along the lines as detailed on the template.



Figure 25: Cut Out Drywall Per Template

Note: Two templates are provided, one for the designer grille and one for the standard grille. Be sure to use the correct template!

Step 3 - Remove Drywall After it is Scored

After the drywall is scored, remove the template and the drywall as indicated. The cutout after removal is shown in figures 26a and 26b.



Figures 26a and 26b: Drywall Removal



Step 4 - Run Speaker Wire from Amplifier Location to In-Wall Subwoofer

Route the wire from the location where the electronics gear is located to where the SC-IW will be. There is extra space between the studs and the box in the event that the wire has to pass along the side of the back box to the driver module.



Figure 27: Speaker Wire Installation

Note: 14 AWG or larger wire is recommended.

Step 5 - Assemble Cabinet and Driver Modules Together

Remove both the back box and driver modules from the packaging and place them on a clean surface. Place the back box with the two silicon rubber tubes facing upward. Remove the two clamp rings from the packaging and place them over the tubes.



Figures 28a and 28b: Cabinet and Driver Module Assembly



Note: Leave the paint cover on the driver to prevent damage during the installation, painting and finishing process.

Step 6 - Mark Installation Location

Measure from the bottom of the cutout $6\frac{3}{8}$ " up along the stud and mark the stud in this location. This location will determine the bottom edge of the bracket on the driver module.

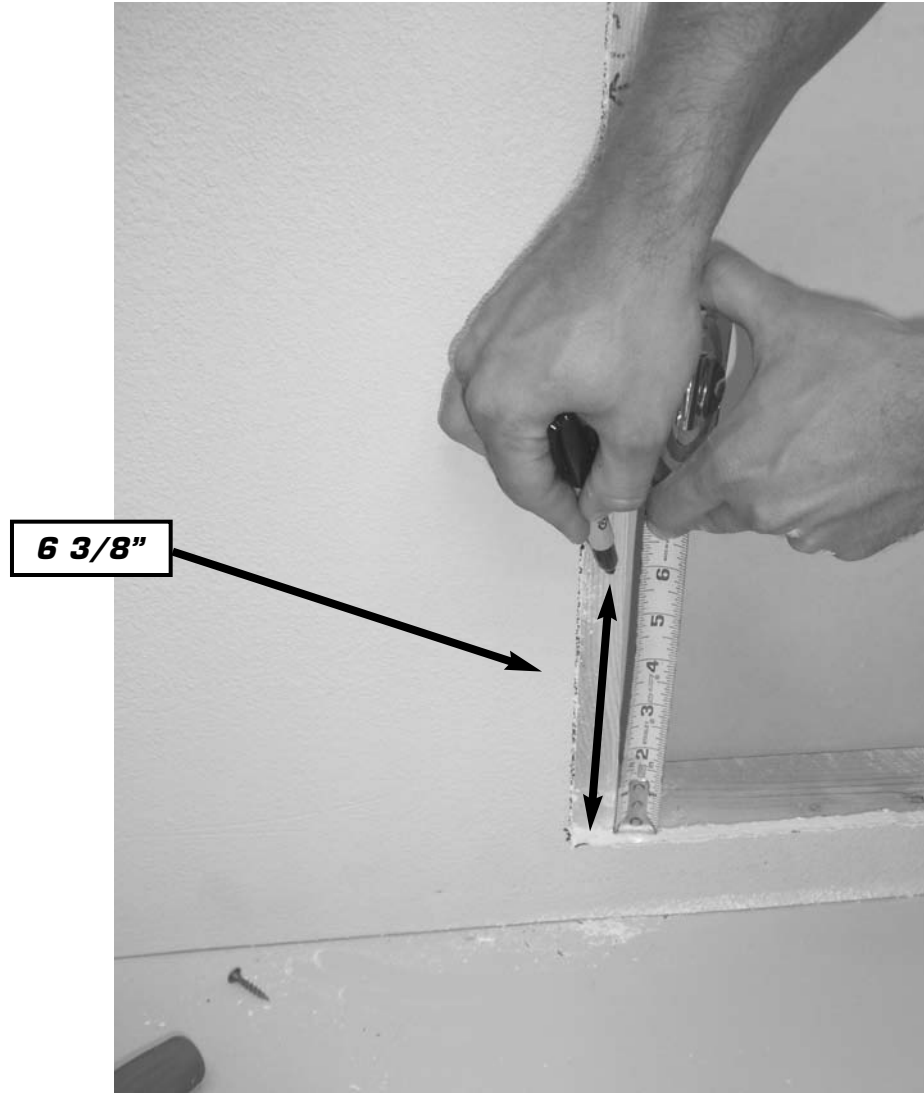

Figure 29: Mark Installation Location

Step 7 - Install Subwoofer into Opening

After the in-wall subwoofer assembly is complete, and the mounting position marked, orient the assembly inside the wall. In this installation example we have decided to face the unit downward. It is critical at this point that the top of the cabinet module is aligned with the top of the cutout and that the brackets are 6 3/8" from the bottom of the cutout.

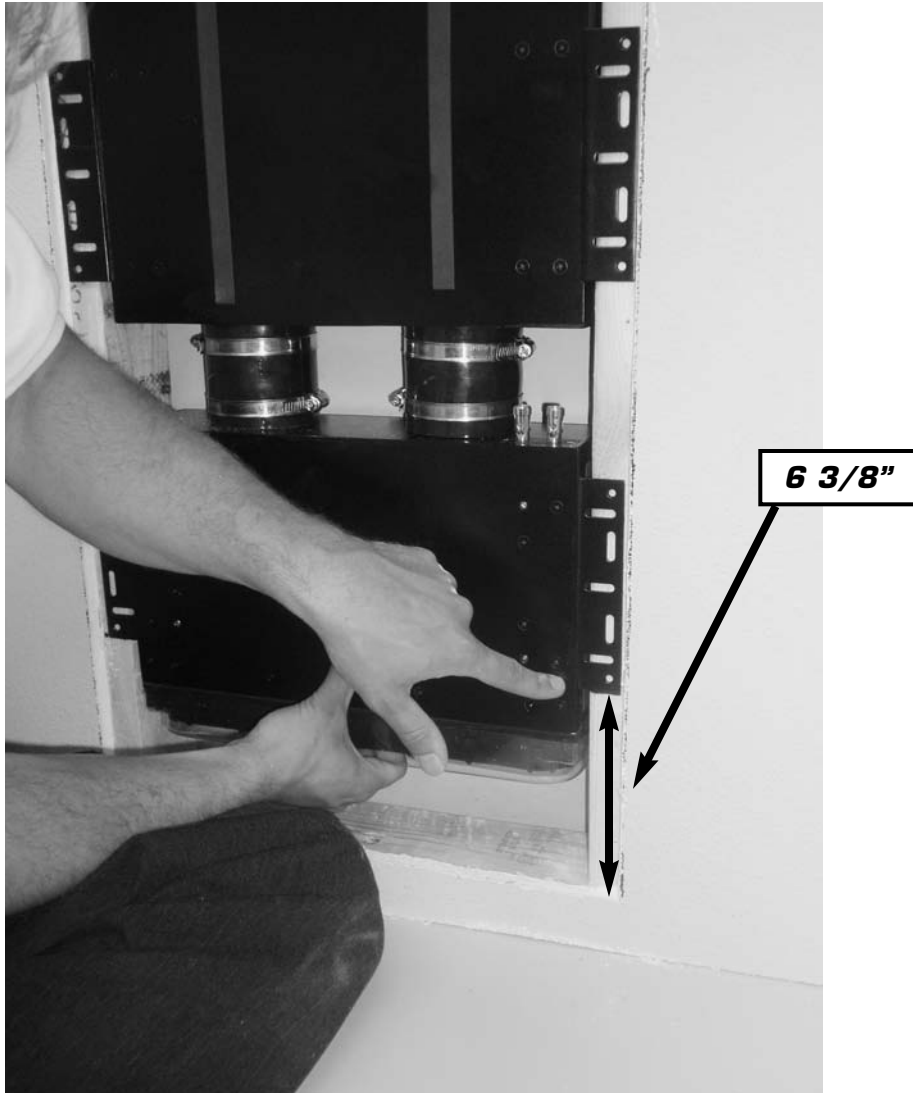

Figure 30: Subwoofer Installation

Step 8 - Secure Subwoofer to Wall

After the location has been determined, securely fasten the subwoofer to the studs. Velodyne provides 12 screws for this purpose.



Figure 31: Secure Subwoofer

Step 9 - Connect Speaker Wire to Subwoofer

Connect the previously routed speaker wire to the subwoofer taking care to match the positive wire to the red terminal and the negative wire to the black terminal. The spring loaded binding post will hold and secure the wire in place.

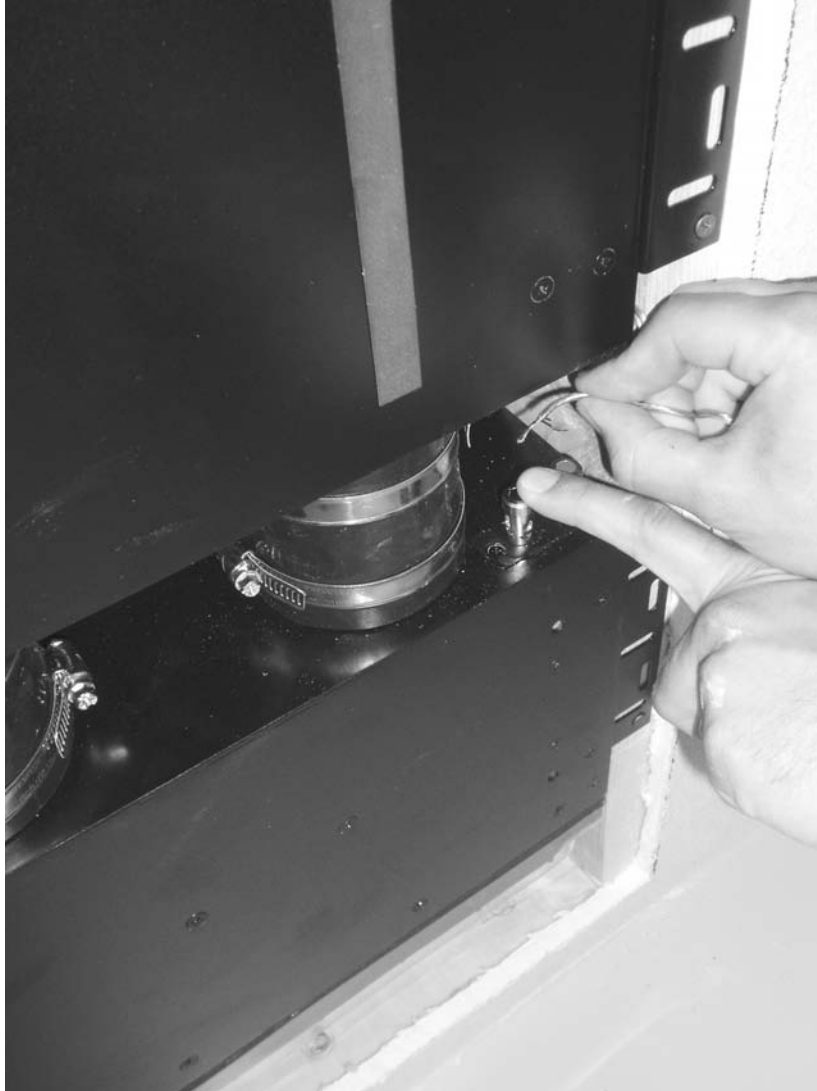

Figure 32: Connect Speaker Wire

Step 10 - Install Filler Panel

Velodyne provides an MDF filler panel to fill the distance between the driver module and the drywall. This filler panel also acts as a guide for the designer grille. The filler panel easily installs using the four flat head screws and included allen wrench. Be sure to orientate the filler panel as shown such that the tapered edge faces way from the driver.

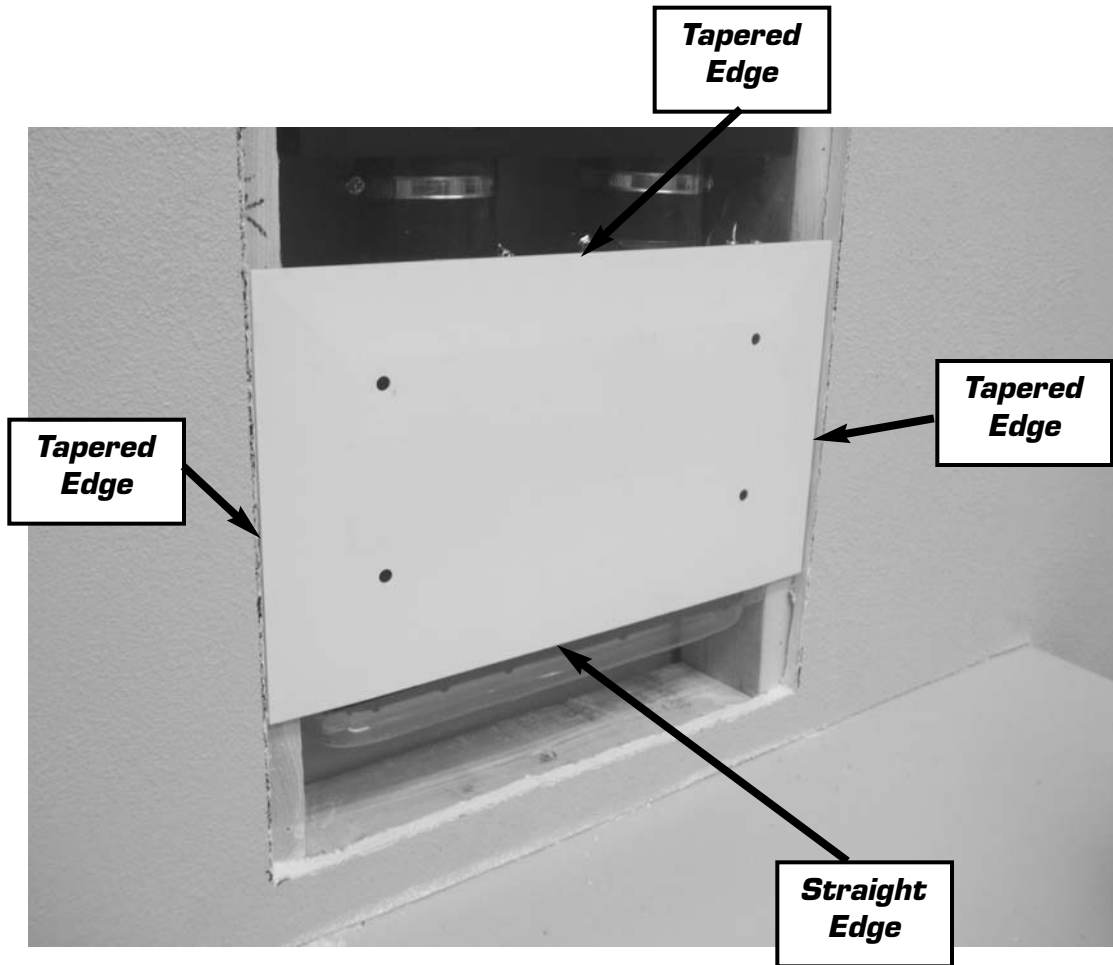

Figure 33: Filler Panel Installation

Step 11 - Install Drywall Above Filler Plate

After the filler plate is secured to the driver module, install a replacement piece of drywall above the filler plate in the opening. This drywall should be securely fastened to the studs using drywall screws.



Figure 34: Drywall Installation

Step 12 - Tape, Mud, Texture and Paint Wall

After the SC-IW is installed into the wall, the wall should be taped, textured, blended and then painted to match the existing wall. Note the grille can also be painted to match the décor.

Note: The paint cover should be remain on the driver until this step is complete.

Step 13 - Install Designer Grille

Remove metal grille insert from the plastic grille and insert into opening into the wall. The grille should then be affixed to the studs using the four included phillips drive pan head screws.

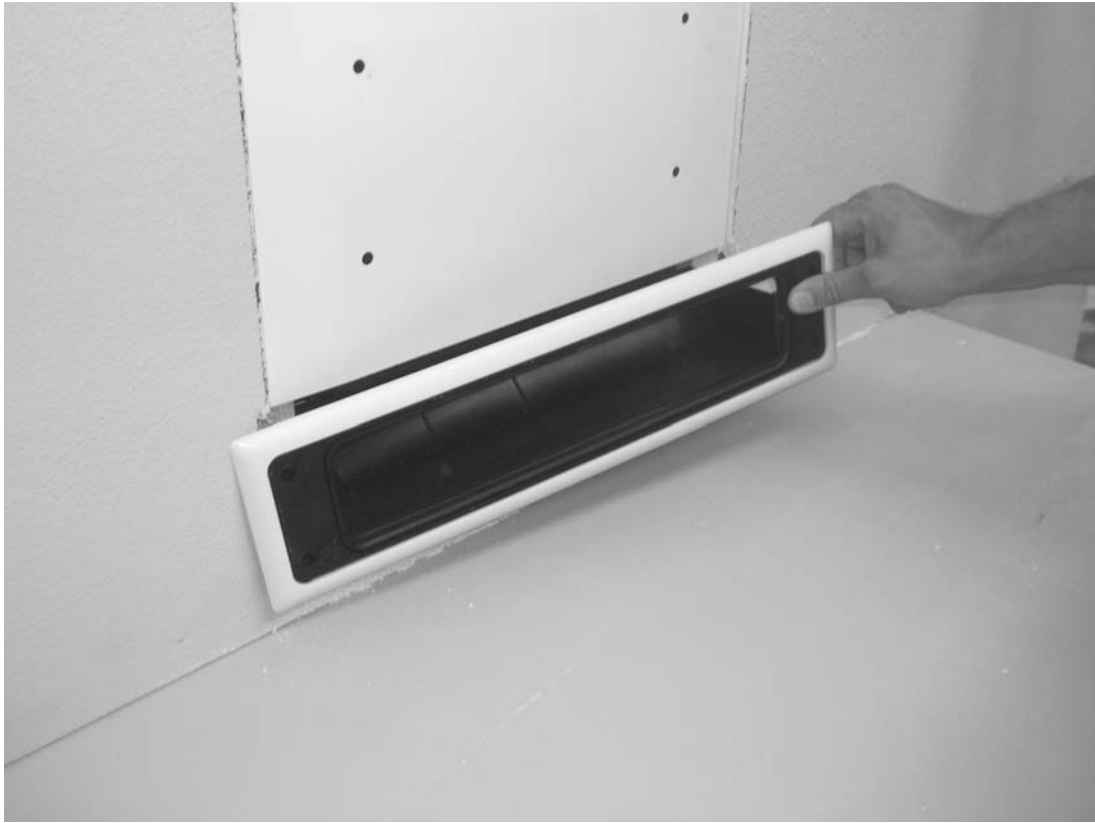

Figures 35a and 35b: Designer Grille Installation



Step 14 - Install Metal Insert into Plastic Grille Frame



Figure 36: Metal Insert Installation

Step 15 - Finished Grille



Figure 37: Finished Grille Installation

RETRO-FIT INSTALLATION WITH STANDARD GRILLE

Step 1 - Decide on Subwoofer Orientation and Grille Location

The first decision for a retrofit installation is which way the subwoofer will face (up or down), and therefore where the standard grille will be located on the wall (near the floor or ceiling). Once the location is decided, locate the 2x4 studs, spaced 16 inches on center. After the general area of the studs is located, the installer needs to determine the exact location of the studs as detailed in the picture below. There are many methods to do this. Shown is the use of a drywall saw used horizontally to find the edge of each stud.



Figure 38: Subwoofer Orientation and Grille Location

Step 2 - Cut Out Drywall Per Template

Once the studs have been located, place the supplied standard grille template on the wall. After the template is secured to the wall with either staples or tape, score the drywall along the lines as detailed on the template.

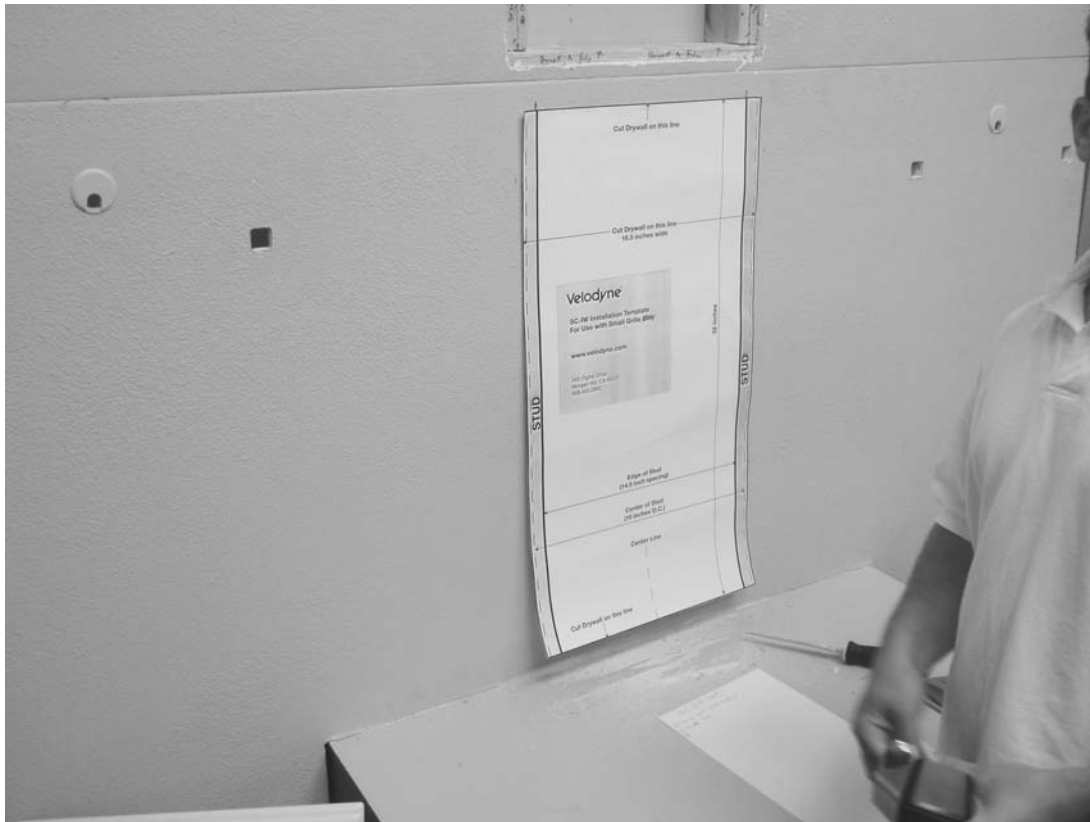

Figure 39: Cut Out Drywall

Note: Two templates are provided, one for the designer grille and one for the standard grille. Be sure to use the correct template!

Step 3 - Remove Drywall After it is Scored

After the drywall is scored, remove the template and the drywall as indicated. The cutout after removal is shown in figures 40a and 40b.



Figures 40a and 40b: Drywall Removal



Step 4 - Run Speaker Wire from Amplifier Location to In-Wall Subwoofer

Route the wire from the location where the electronics gear is located to where the SC-IW will be. There is extra space between the studs and the box in the event that the wire has to pass along the side of the back box to the driver module.



Figure 41: Speaker Wire Installation

Step 5 - Assemble Cabinet and Driver Modules Together

Remove both the back box and driver modules from the packaging and place them on a clean surface. Place the back box with the two silicon rubber tubes facing upward. Remove the two clamp rings from the packaging and place them over the tubes.



Figures 42a and 42b: Cabinet and Driver Module Assembly



Note: Leave the paint cover on the driver to prevent damage during the installation, painting and finishing process.

Step 6 - Mark Installation Location

Measure from the bottom of the cutout 5 3/8" up along the stud and mark the stud in this location. This location will determine the bottom edge of the bracket on the driver module.

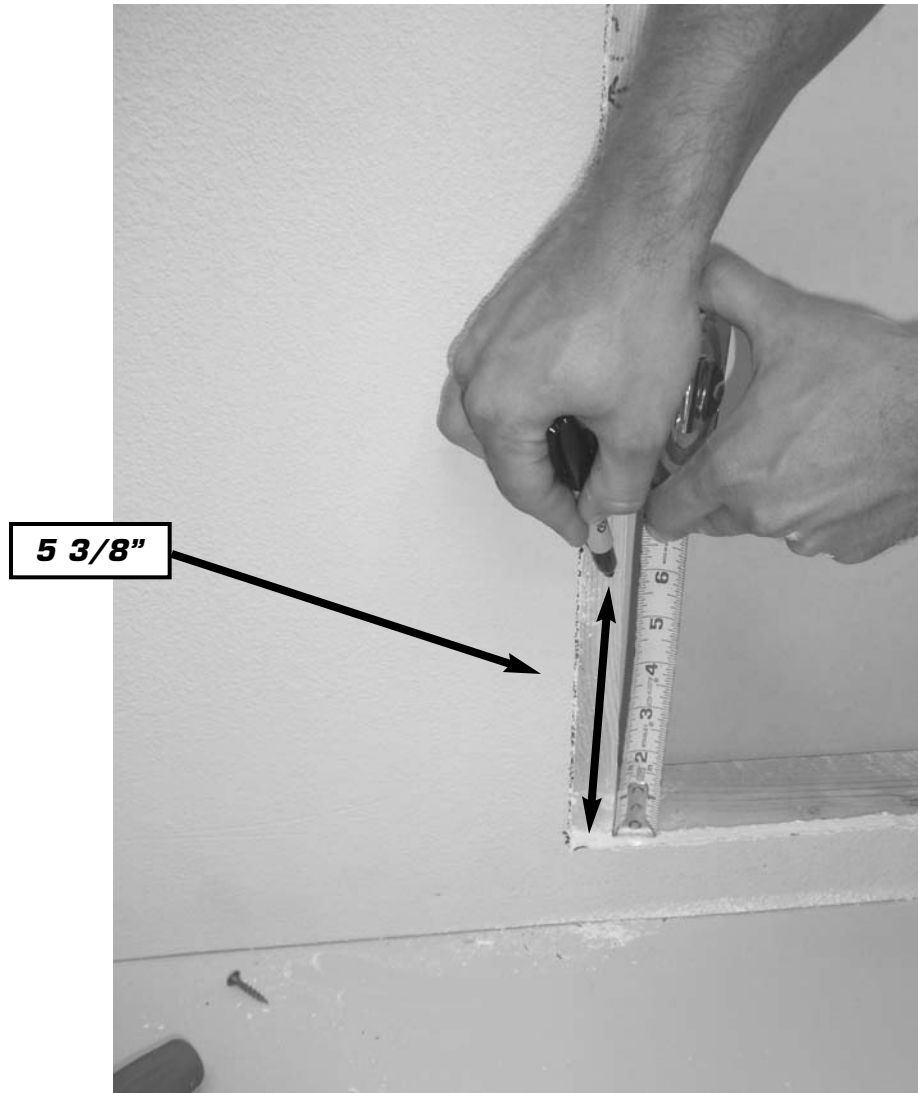

Figure 43: Mark Installation Location

Step 7 - Install Subwoofer into Opening

After the in-wall subwoofer assembly is complete, orientate the assembly inside the wall. In this installation example we have decided to face the unit downward. It is critical at this point that the top of the cabinet module is aligned with the top of the cutout and that the brackets are 5 3/8" from the bottom of the cutout.

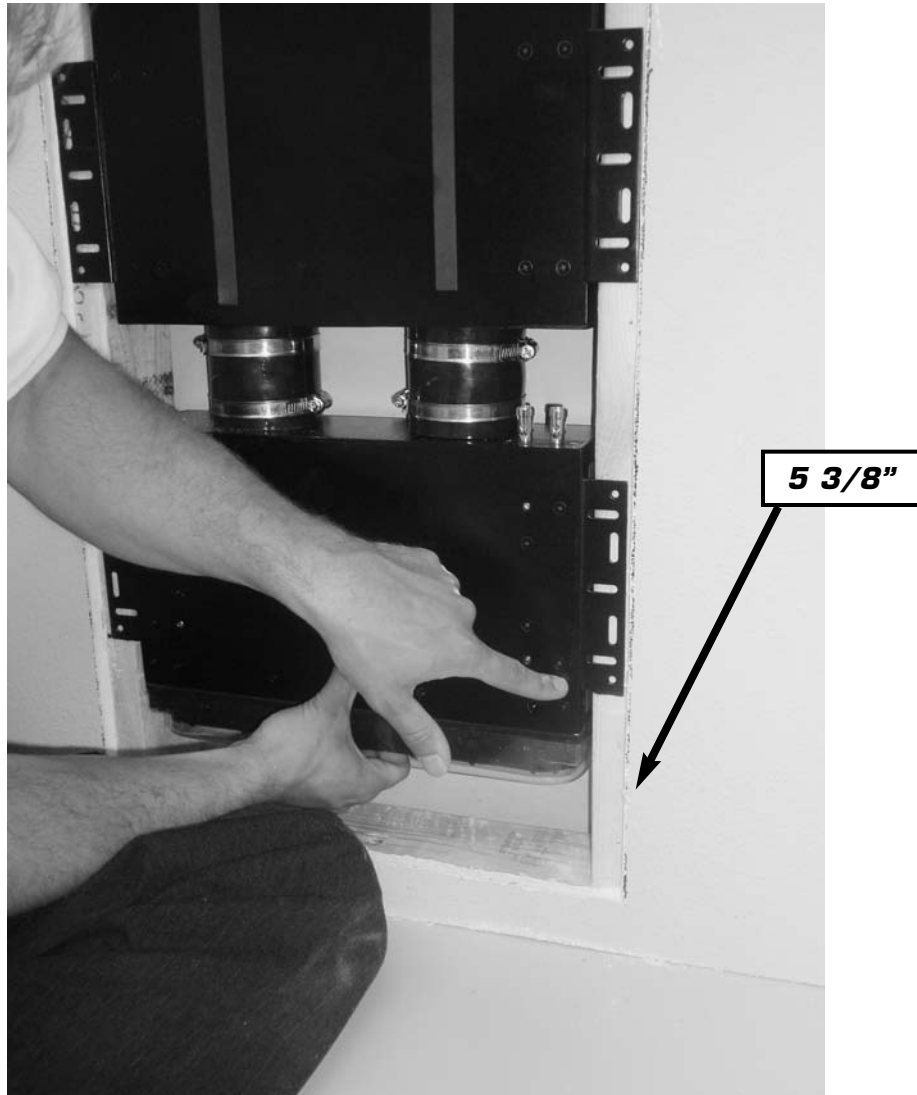

Figure 44: Subwoofer Installation

Step 8 - Secure Subwoofer to Wall

After the location has been determined, securely fasten the subwoofer to the studs. Velodyne provides 12 screws for this purpose.



Figure 45: Secure Subwoofer

Step 9 - Connect Speaker Wire to Subwoofer

Connect the previously routed speaker wire to the subwoofer taking care to match the positive wire to the red terminal and the negative wire to the black terminal. The spring loaded binding post will hold and secure the wire in place.



Figure 46: Speaker Wire Installation

Step 10 - Install Filler Panel

Velodyne provides an MDF filler panel to fill the distance between the driver module and the drywall. This filler panel also acts as a guide for the standard grille. The filler panel easily installs using the four flat head screws and included allen wrench. Be sure to orientate the filler panel as shown such that the tapered edge faces way from the driver.

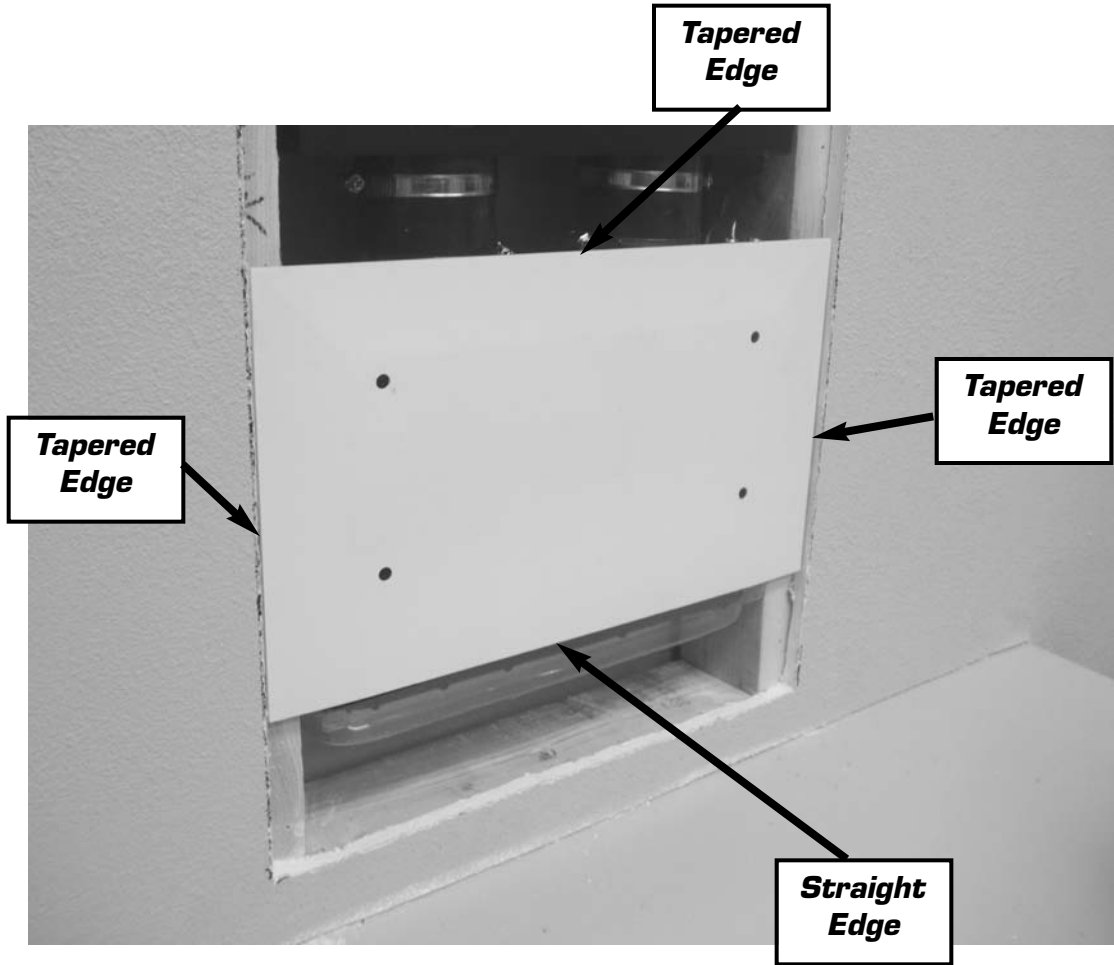

Figure 47: Filler Panel Installation

Step 11 - Install Drywall Above Filler Plate

After the filler plate is secured to the driver module, install a replacement piece of drywall above the filler plate in the opening. This drywall should be securely fastened to the studs using drywall screws.



Figure 48: Drywall Installation

Step 12 - Tape, Mud, Texture and Paint Wall

After the Velodyne subwoofer is installed into the wall, the wall should be taped, textured, blended and then painted to match the existing wall. It is not required to finish the filler plate as it will be removed in the next step.

Note the grille can also be painted to match the décor. The supplied paint masks can be used to paint the grille frame while the metal grille insert can be painted separately.

Note: The paint cover should remain on the driver until this step is complete.

Step 13 - Remove Metal Grille

Remove the filler plate. Obtain the standard grille with integrated scoop and remove metal grille insert, as shown, in the picture below.



Figure 49: Metal Grille Insert Removal

Step 14 - Install Grille Frame

Install the plastic grille onto the driver module using the four included machine screws. The grille hardware should easily be installed into the side of the cabinet. Tighten using the supplied allen wrench.

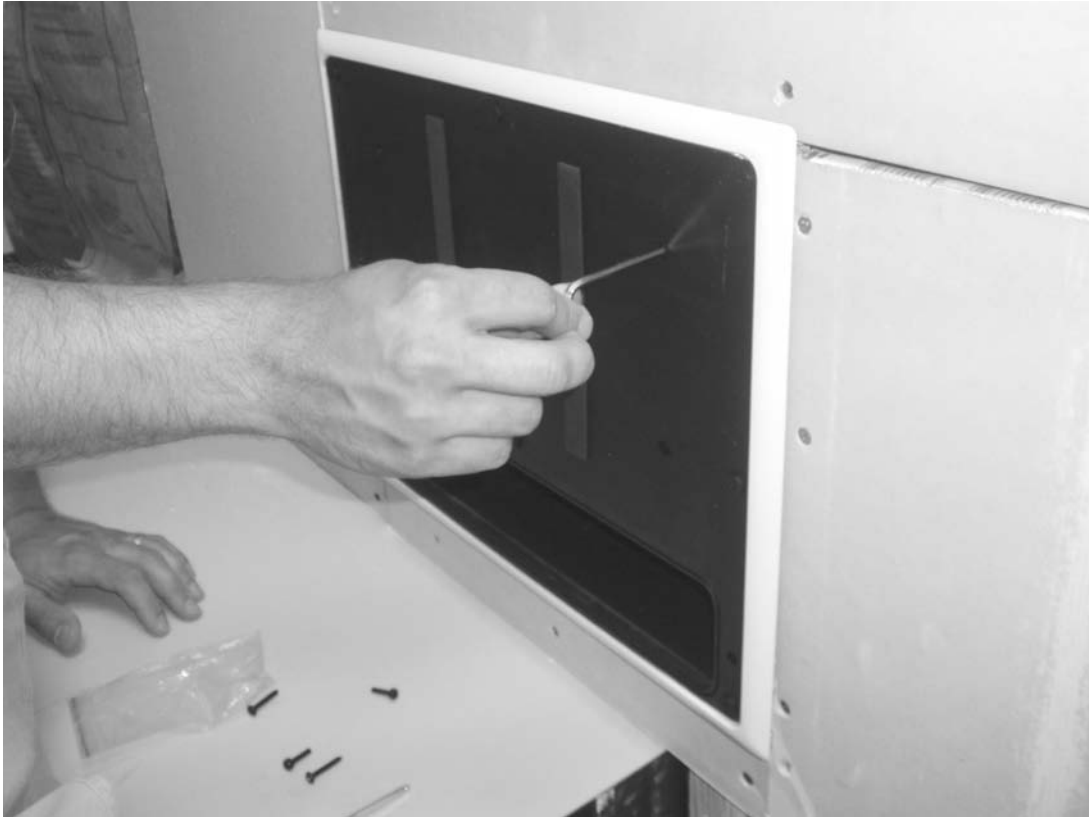

Figure 50: Grille Frame Installation

Step 15 - Secure Grille

Install two pan head phillips screws (provided) into standard grille into bottom left and bottom right holes.

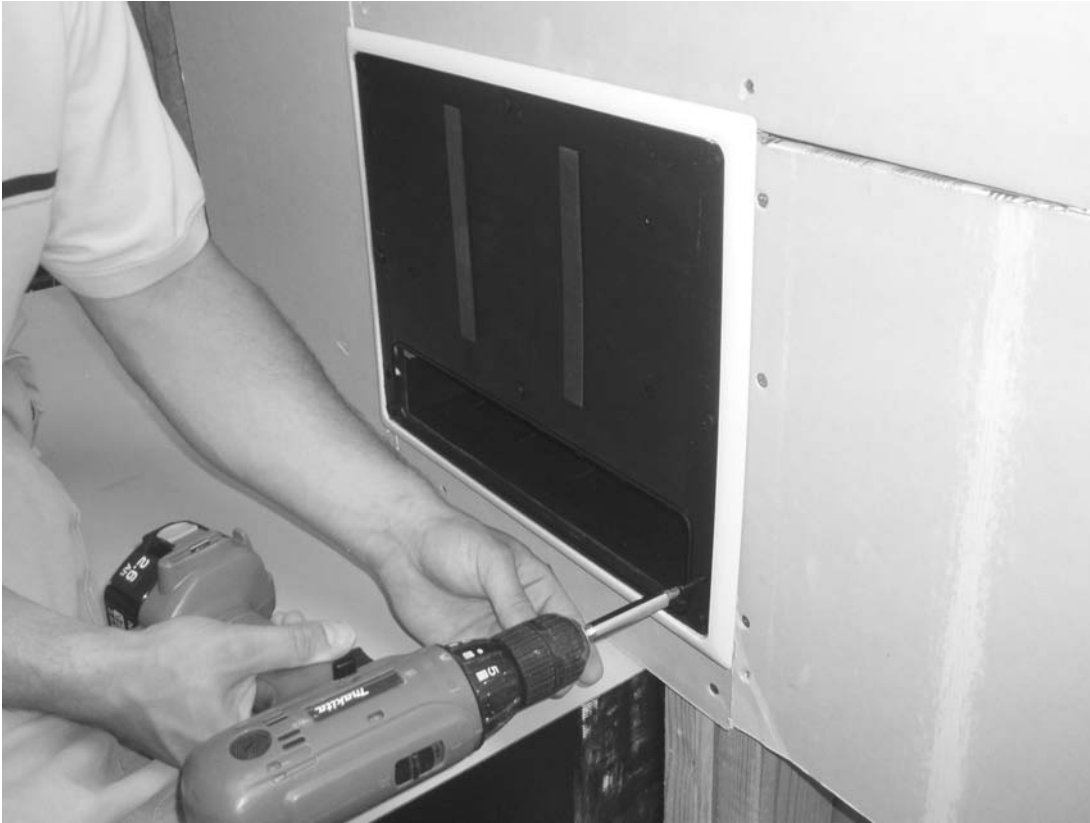

Figure 51: Secure Grille

Step 16 - Install Metal Grille Insert

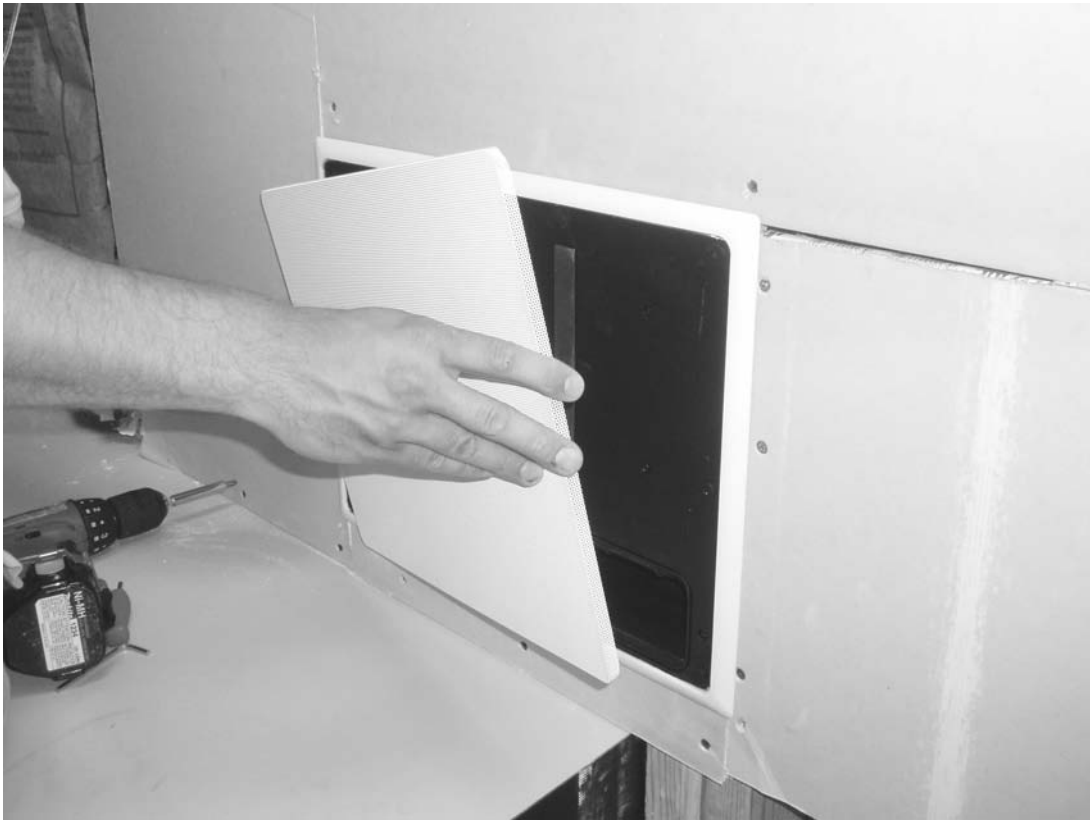

Figure 52: Metal Grille Insert Installation

Step 17 - Installation Complete

The installation is complete. Test the installation with bass audio material and check for buzzes, rattles, and air leaks and address accordingly.

The grille can also be painted to match the décor if desired.



Figure 53: Completed Installation

OTHER VELODYNE SUBWOOFER PRODUCTS

110V

DD Series

DD-10
DD-12
DD-15
DD-18

***Digital Drive 1812
Signature Edition***

DLS-R Series

DLS-3500R
DLS-3750R
DLS-4000R
DLS-5000R

DPS Series

DPS-10
DPS-12

MiniVee™

SMS™-1

SPL-R Series

SPL-800R
SPL-1000R
SPL-1200R
SPL-1500R

VRP Series

VRP-1000
VRP-1200

VX Series

VX-10

230V

DD Series

DD-10
DD-12
DD-15
DD-18

***Digital Drive 1812
Signature Edition***

CHT-R Series

CHT-8R
CHT-10R
CHT-12R
CHT-15R

SMS™-1

SPL-800i

SPL-R Series

SPL-800R
SPL-1000R
SPL-1200R
SPL-1500R

LIMITED WARRANTY

VELODYNE ACOUSTICS, Inc. ("VELODYNE") warrants all electronics and powered subwoofers for a period of two years and full range speakers for a period of five years. All VELODYNE products have a warranty from the date of purchase against defects in materials and workmanship subject to the following conditions:

1. VELODYNE is not responsible for defects which result from the use of an amplifier or controller other than the one originally supplied with the unit (subwoofer) or defects which result from modifications or repairs made by any component of the system by anyone other than a VELODYNE factory authorized service representative.
2. This warranty is void if any repairs or service covered by the terms of this warranty are made to any component of the system by anyone other than a VELODYNE factory authorized service representative.
3. VELODYNE is not responsible for damage caused by accidents, abuse, misuse, natural or personal disaster or unauthorized modification. The VELODYNE products are not intended for professional or commercial use and VELODYNE is not responsible for damage resulting from such use.
4. The VELODYNE product warranty is limited to units that are purchased from authorized VELODYNE dealers and finalized within authorized dealer locations.
5. This warranty is nontransferable under any condition.

TO OBTAIN SERVICE

Information regarding service may be obtained from the dealer from whom you purchased the unit, or by contacting VELODYNE customer service. Warranty service must be performed by a VELODYNE factory authorized service representative within the warranty period set forth above. If VELODYNE determines the unit is defective, VELODYNE will, at VELODYNE's option, repair or replace the product at no charge if the product is forwarded prepaid to a factory authorized service representative. Products forwarded to the factory authorized service representative should be shipped securely and properly packaged, insured and freight prepaid.

Velodyne Acoustics, Inc.

345 Digital Drive
Morgan Hill, CA 95037

408.465.2800 voice
408.779.9227 fax
408.779.9208 service fax

www.velodyne.com
Service E-mail: service@velodyne.com
Product E-mail: help@velodyne.com
Technical E-mail: techhelp@velodyne.com



63-SCIWBB REV B SEPO6