



DS31-EZ | Install Instructions For:

DS31-EZ

Box contents

- (1) Speaker assembly
- (1) Cylindrical or Tapered sleeve
- (2) Safety cables
- (2) Speed clamps
- (5) Zip ties
- (1) Magnetic grille
- (1) Mounting Assembly
- (2) Mounting screws
- (2) 2.25" sleeve screws
- (2) 0.50" screws
- (2) Wire nuts

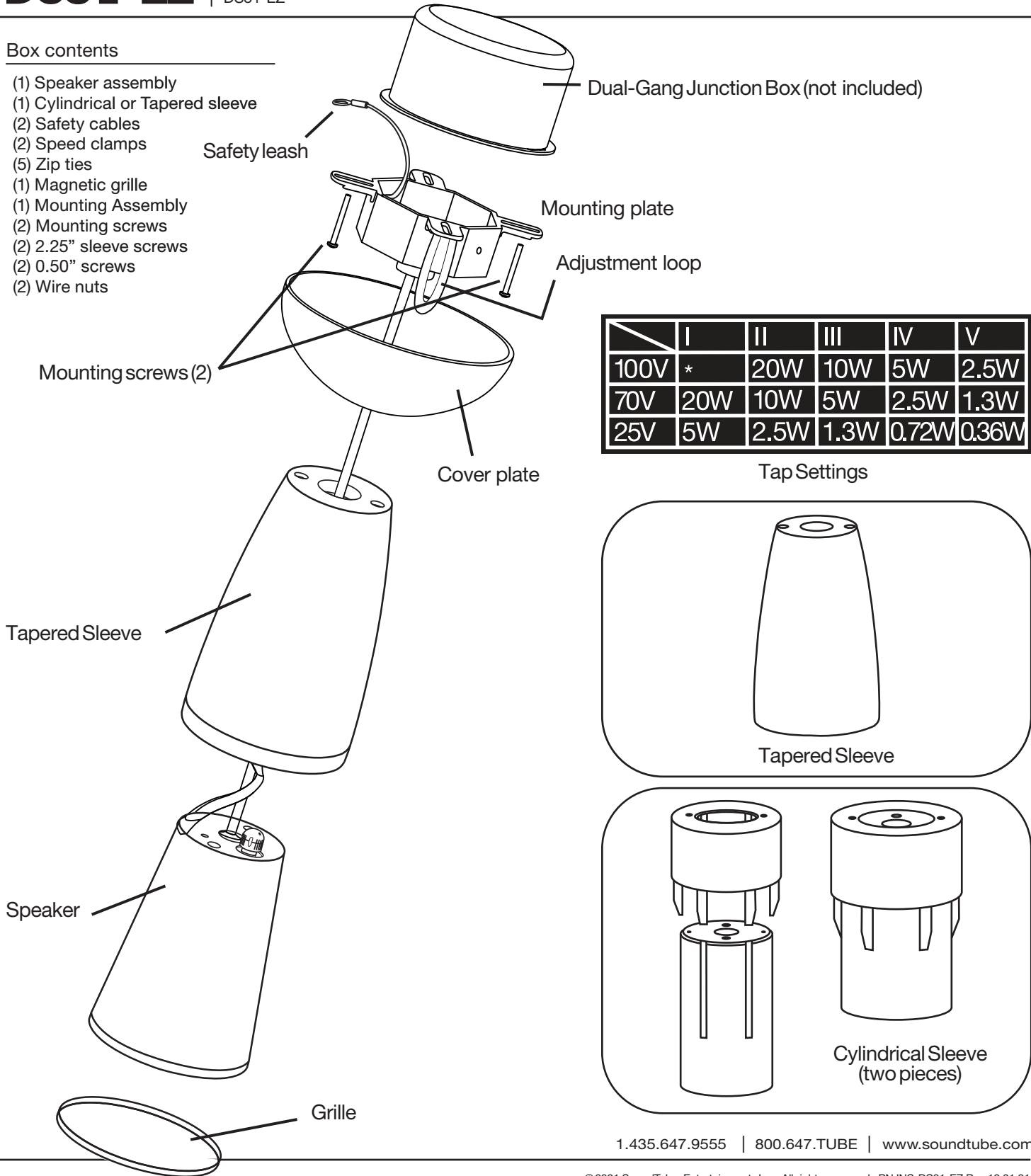

| | I | II | III | IV | V |
|------|-----|------|------|-------|-------|
| 100V | * | 20W | 10W | 5W | 2.5W |
| 70V | 20W | 10W | 5W | 2.5W | 1.3W |
| 25V | 5W | 2.5W | 1.3W | 0.72W | 0.36W |

Tap Settings

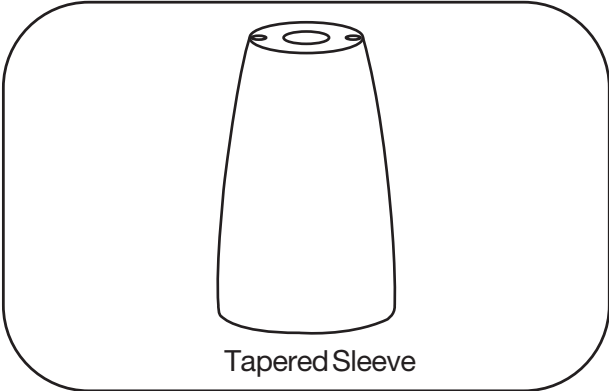

Tapered Sleeve

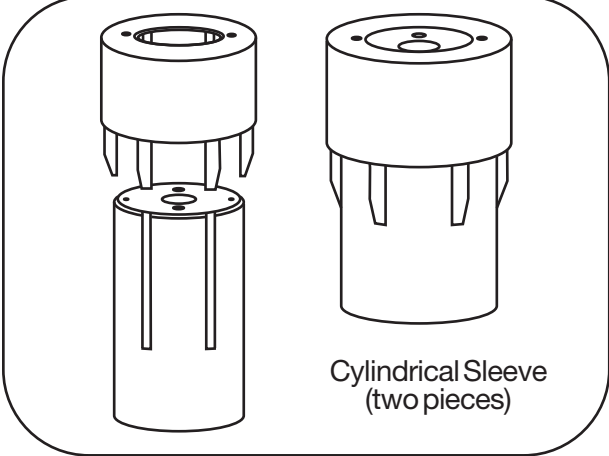

Cylindrical Sleeve (two pieces)

1.435.647.9555 | 800.647.TUBE | www.soundtube.com

©2021 SoundTube Entertainment, Inc. All rights reserved. PN INS-DS31-EZ Rev 12.01.21

| | |
|---|--|
| <p>Warning</p> <p>SoundTube speakers must be installed by a professional audio installer/contractor. For safety and for optimum audio performance, installer must follow all directions issued by SoundTube Entertainment.</p> | <p>Warning</p> <p>Do not spec or install speaker near support beam, ventilation duct or other structure that may interfere with speaker function or dispersion.</p> |
|---|--|

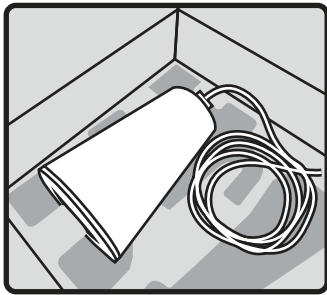

1. Remove speaker body from box and unravel signal wire.

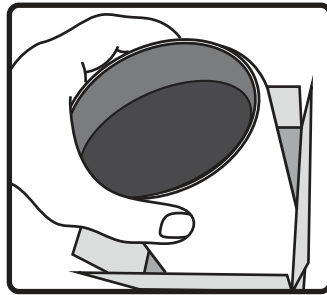

2. Unpack Designer Sleeve.

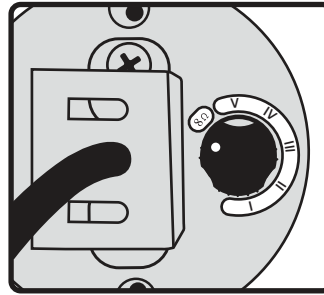

3. Select tap setting on the back face of the speaker body. Each numeral setting corresponds to a wattage shown in tap setting table on back of speaker (also shown on Page 1). Use 8Ω for transformer bypass.

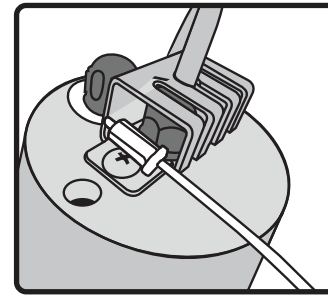

4. If necessary, attach safety cable by first inserting into side of mounting bracket.

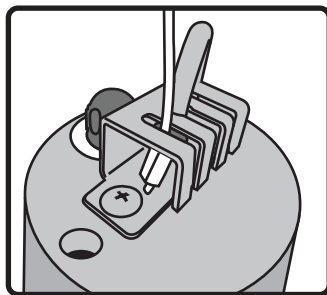

5. Align safety cable with bracket slot and pull up to secure.

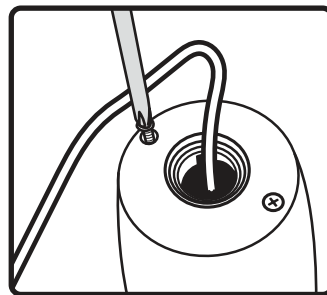

6. Thread signal wire through Designer Sleeve central hole, then use two included 2.25" Phillips-head screws to secure sleeve to speaker body (Tapered Sleeve shown).

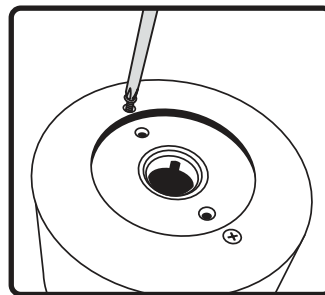

7. If using both Cylindrical Sleeve pieces, use two included 0.50" Phillips-head screws to secure the two sleeve pieces to one another.

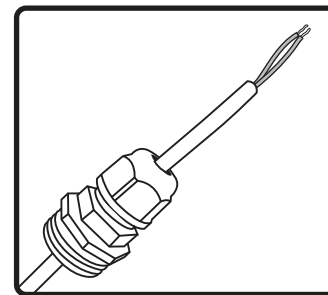

8. Thread signal wire through included Strain Relief Bushing.

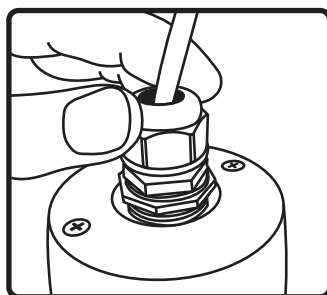

9. Screw bushing into Designer Sleeve, pulling excess wire through until snug.

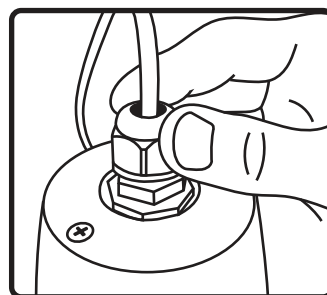

10. Tighten down top gland to secure the signal wire. Gland must be tightened around signal cable to prevent water ingress and maintain IP rating.

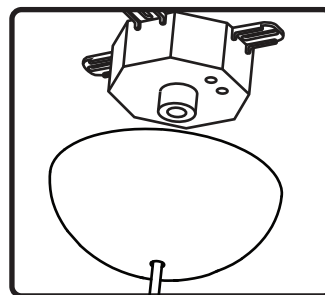

11. Unpack Mounting Assembly and separate hemispherical cover plate from mounting plate. Thread signal wire through hemispherical cover plate and central hole in mounting plate.

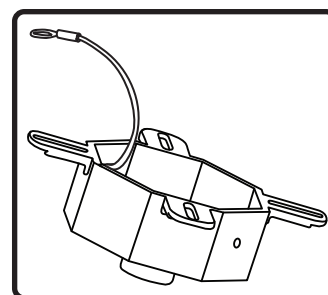

12. Where needed, connect safety leash to secure point on structure/ junction box.

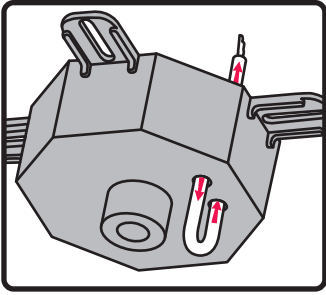

13. Loop wire down through one of the smaller holes on the mounting plate, then back up through adjacent hole. Run signal wire from amplifier to the speaker and connect it to the speaker's signal wire using included wire nuts. Red is positive, black is negative.

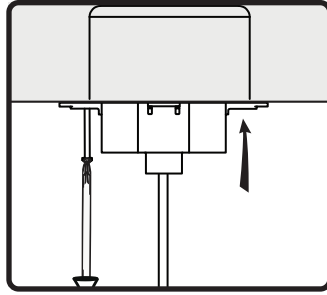

13. Screw mounting plate into the junction box (not included) using the mounting screws provided.

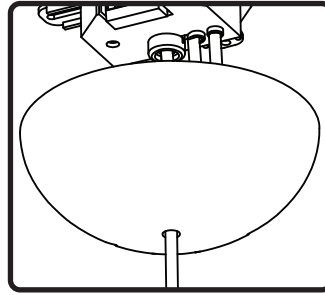

15. Move cover plate up speaker wire, begin to thread cover plate into mounting plate, leaving half an inch between cover plate and mounting surface.

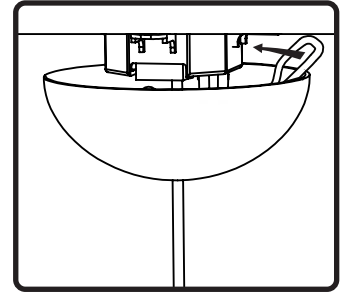

16. Excess wire can be hidden inside of cover plate by wrapping excess wire clockwise and into gap between plate and surface.

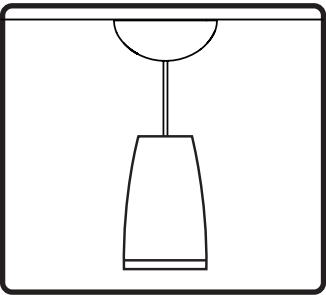

17. Completely thread cover plate to secure speaker.

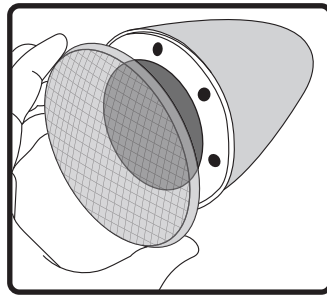

18. Unpack grille and magnetically attach it to the front of the speaker. Done.