

Alva Duo

Manual Generated: 15/12/2023 - 16:28

Table of Contents

Alva Duo	3
Introduction	4
What's included with the Alva Duo?	5
Front panel controls	6
Rear panel	7
Getting connected	8
Auto power down (APD)	9
What is the difference between a moving magnet cartridge and a moving coil cartridge?	10
Troubleshooting	11
Technical specifications	12

Alva Duo

Last updated: July 14, 2022 06:00. Revision #5986

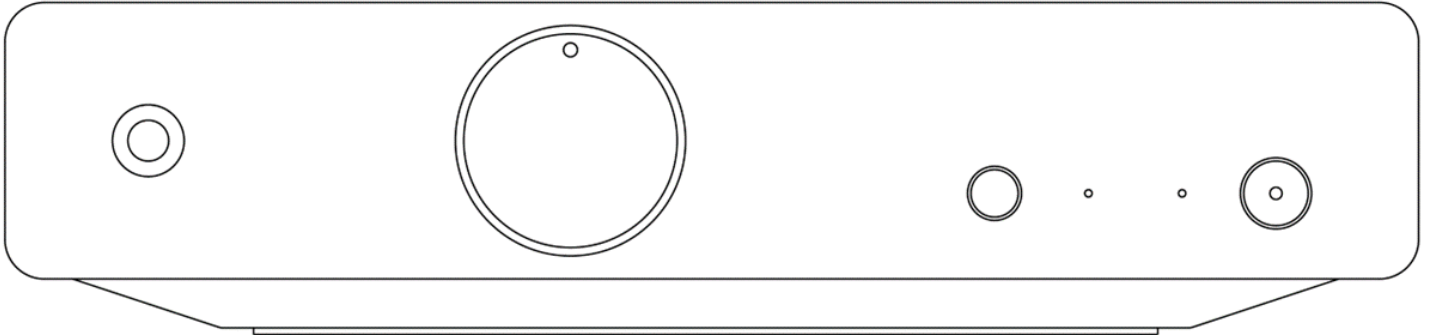

Users Manual

Introduction

Last updated: July 13, 2022 09:21. Revision #5994

This guide is designed to make installing and using this product as easy as possible. Information in this document has been carefully checked for accuracy at the time of printing; however, Cambridge Audio's policy is one of continuous improvement, therefore design and specifications are subject to change without prior notice.

This document contains proprietary information protected by copyright. All rights are reserved. No part of this manual may be reproduced by any mechanical, electronic or other means, in any form, without prior written permission of the manufacturer. All trademarks and registered trademarks are the property of their respective owners.

© Copyright Cambridge Audio Ltd

For upcoming news on future products, software updates and exclusive offers, make sure you register your product at <http://www.cambridgeaudio.com/register>

What's included with the Alva Duo?

Last updated: June 30, 2022 11:32. Revision #5993

Inside the box of your Alva Duo you will receive:

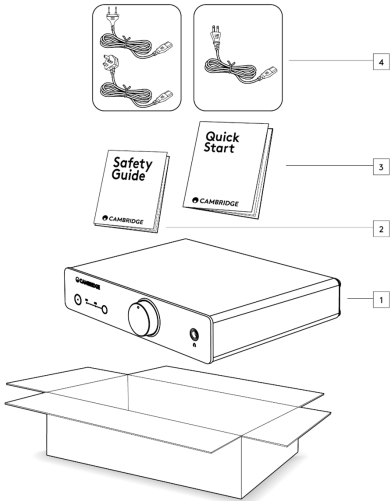

1. Alva Duo Moving Magnet Phono Preamplifier.
2. Safety Guide.
3. Quick Start Guide.
4. UK power cord (5A fused) (Depending on which country the Alva Duo was purchased in),
EU power cord (Depending on which country the Alva Duo was purchased in),
CU power cord (Depending on which country the Alva Duo was purchased in)

Front panel controls

Last updated: June 28, 2022 03:30. Revision #5992

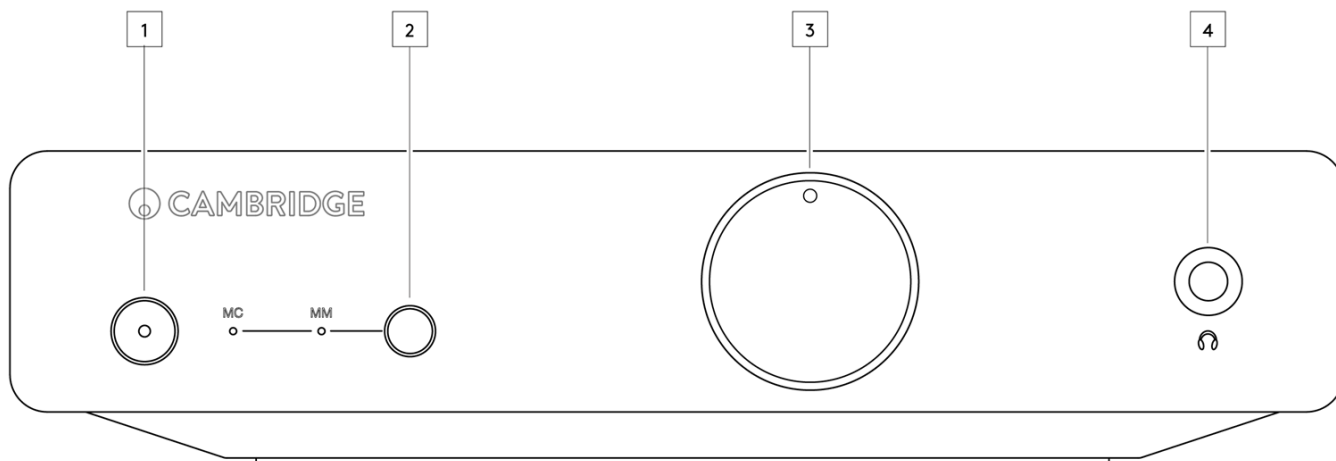

1. Standby/On - Switches the unit between Standby mode (indicated by dim LED) and On (indicated by bright LED). Standby mode is a low power mode where the power consumption is less than 0.5 Watts.

2. Cartridge Type Selector Switch - Match this switch to the cartridge type installed on your turntable. MM for a moving magnet cartridge and MC for a moving coil cartridge.

3. Headphone Volume Control.

4. Headphone Output - Allows for the connection of stereo headphones with a 1/4" Jack plug. Headphones with an impedance of between 32 and 600 ohms are recommended.

Rear panel

Last updated: June 28, 2022 03:30. Revision #5991

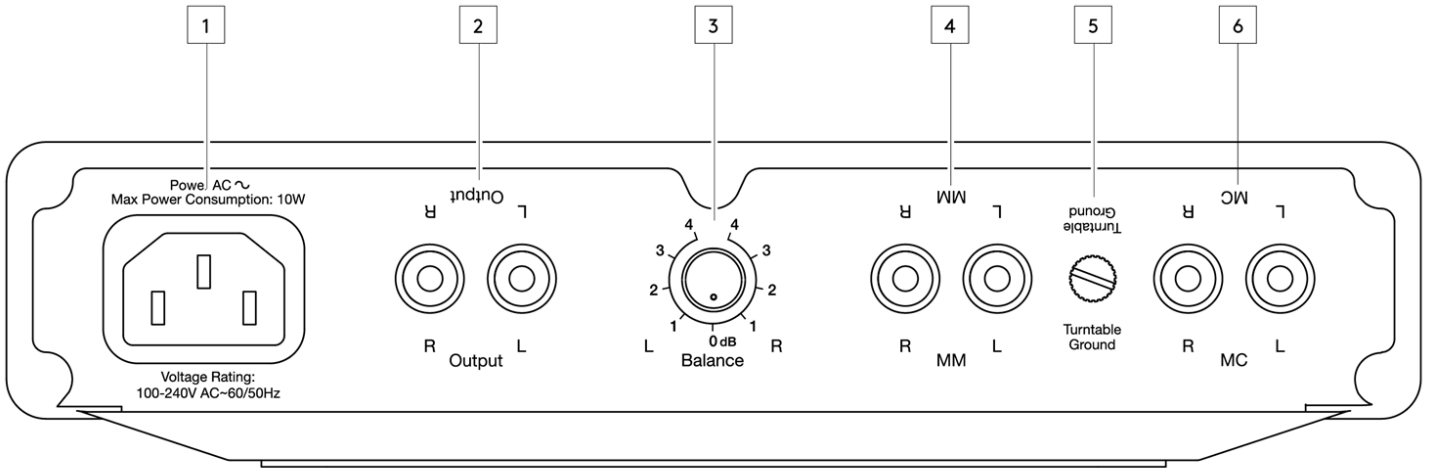

1. AC Power Socket.

2. Signal Output Sockets - RCA connections used to connect to a line-level input.

Note: Do not connect to a phono-level input.

3. Balance Control - Used to make fine adjustments to the relative output levels of the left and right channels. In the central position the output from each channel is equal.

4. MM Input Sockets - RCA connections used to connect to a turntable fitted with a moving-magnet cartridge.

5. Ground Connection Screw - If your turntable has a separate grounding lead then connect here. This provides shielding to the tonearm and the sensitive circuitry in the turntable.

6. MC Input Sockets - RCA connections used to connect to a turntable fitted with a moving-coil cartridge.

Note: Recommended cartridge specifications 0.3-1mV output voltage, 100ohm/100pF loading.

Getting connected

Last updated: July 13, 2022 09:21. Revision #5990

Initial Setup

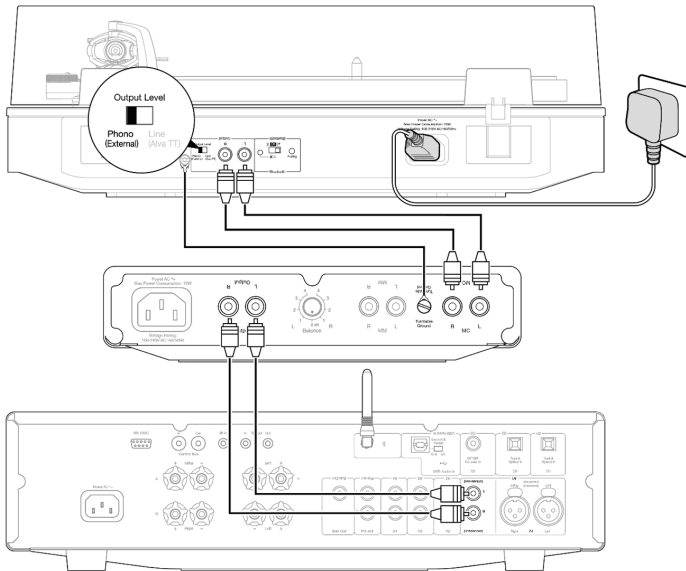

1. Firstly, using high quality RCA interconnects, connect the outputs of your turntable to the MM input socket of the Alva Duo if fitted with a moving magnet cartridge, or the MC input socket if fitted with a moving coil cartridge.
2. If your turntable uses a separate ground lead, connect this to the ground screw on the Alva Duo. This reduces any potential hum or buzzing.
3. Connect the signal output sockets of the Alva Duo to a line-level input on your amplifier.
4. Ensure that the balance control is set to the central position. This can be adjusted later if necessary.
5. Attach the mains power lead securely to the Alva Duo and power on the unit.
6. Using the cartridge type selection switch, set the Alva Duo to MM for use with a moving magnet cartridge, or MC for use with a moving coil. This will be indicated by the relevant LED.

Auto power down (APD)

Last updated: June 28, 2022 03:30. Revision #5989

The Alva Duo comes set up with Auto Power Down (APD) enabled and will automatically switch to standby mode after 20 minutes of inactivity.

To disable Auto Power Down (APD): If you wish to disable the APD function, then press and hold the power button for 5 seconds when in standby. This can then be reset to factory defaults by plugging in the mains lead with the standby button held down

What is the difference between a moving magnet cartridge and a moving coil cartridge?

Last updated: July 13, 2022 09:21. Revision #5988

The cartridge mounted to the tonearm of your turntable uses a small stylus tip, made of diamond, to convert the information held within the groove of a record to a signal which can then be amplified for listening.

During playback the stylus tip, attached to a cantilever, is dragged through a records groove at a consistent speed, tracing the landscape of the record itself. The physical variations within the groove causes this assembly to vibrate, and it is this physical movement which can then be converted into an electrical signal through electromagnetic induction.

Electromagnetic induction is a phenomenon that occurs when an inductor is placed within a varying magnetic field. As this magnetic field changes, a current will be induced within the inductor proportional to the rate of change of the field. This principle is integral to the function of a cartridge and is achieved using magnets and coils of wire.

Moving Magnet Cartridges

A moving magnet cartridge uses magnets fixed to the end of the cantilever. These magnets sit within a static set of wire coils, moving within these coils as the stylus travels along the record groove.

This movement causes a variation in the magnetic field, inducing a small current within the coils that corresponds to the movement of the stylus. This current can then be amplified for listening using a phono preamplifier.

Moving Coil Cartridges

The principle remains the same for a moving coil cartridge, with the primary difference being that in this assembly the coils are mounted upon the cantilever, whilst the magnets remain fixed.

In this formation it is the coils that move in relation to the magnets, causing a variation in the magnetic field, and in turn inducing a small current. These coils of wire are often much smaller than those used in a moving magnet cartridge, and due to this the signal generated tends to be of a much lower level. Therefore, moving coil cartridges require a preamplifier with a dedicated MC input to provide the additional gain necessary for optimum performance.

As the coils are mounted directly to the cantilever of a moving coil cartridge, the cantilever assembly itself is much lighter in comparison to that of a moving magnet cartridge. This lightweight design contributes to an improved transient response, better clarity during quieter sections of audio, and more detailed reproduction overall. However, cartridges of this type are therefore much more delicate and tend not to have any user-replaceable parts as can be seen in many moving magnet cartridges.

Troubleshooting

Last updated: June 28, 2022 03:30. Revision #5987

There is no power.

- Ensure that the AC power cord is securely connected.
- Check that the plug is fully connected to the mains and is switched on.
- Check the fuse in the mains plug.

There is no sound.

- Confirm that the unit is switched on.
- Check that the turntable is securely connected to the Alva Duo.
- Check that the connections between the Alva Duo and amplifier are securely made.
- Ensure that your speakers are properly connected.

There is no sound on one channel.

- Check speaker connections and interconnects.
- Check that the Alva Duo balance control is set centrally.

There is a loud buzz or hum.

- Check that the ground lead (if present) is securely connected to both the turntable and Alva Duo.
- Ensure all interconnects are secure and intact.
- Check that your turntable is not too close to your amplifier.

There is weak bass or diffused stereo imaging.

- Ensure that your speakers are not wired out of phase.

Volume is too loud/quiet.

- Confirm that the cartridge type being used matches that of the input it is connected to.

Technical specifications

Last updated: July 13, 2022 09:39. Revision #5995

Maximum Power Consumption

10W

Standby Consumption

<0.5W

Mains Inlet Voltage

100-240V AC

Gain @ 1kHz

39dB (Moving magnet)

60dB (Moving coil)

Nominal Output

300mV

Sensitivity for Nominal Output

3.35mV (Moving magnet)

305uV (Moving coil)

Equivalent Input Noise (A-Weighted)

~0.09uV (Moving magnet)

~0.08uV (Moving coil)

RIAA Curve Accuracy

+/- 0.3dB 30Hz - 20kHz

Signal to Noise Ratio Grounded Inputs ref. 1V Output (20Hz - 20kHz BW)

>90dB (Moving magnet)

>70dB (Moving coil)

THD+N 1kHz (20Hz - 20kHz BW)

<0.0025% (Moving magnet)

<0.020% (Moving coil)

Input Impedance

47k Ohm (Moving magnet)

100 Ohm (Moving coil)

Input Capacitance

100pF

Overload Margin

>30dB

Crosstalk @ 20kHz

>85dB (Moving magnet)

>75dB (Moving coil)

Subsonic Filter Characteristics

-3dB @ 15Hz 12dB/octave

Dimensions (H x W x D)

48 x 215 x 159 mm (1.9 x 8.5 x 6.2 ")

Weight

0.95kg (2.1lbs)