

FRONT

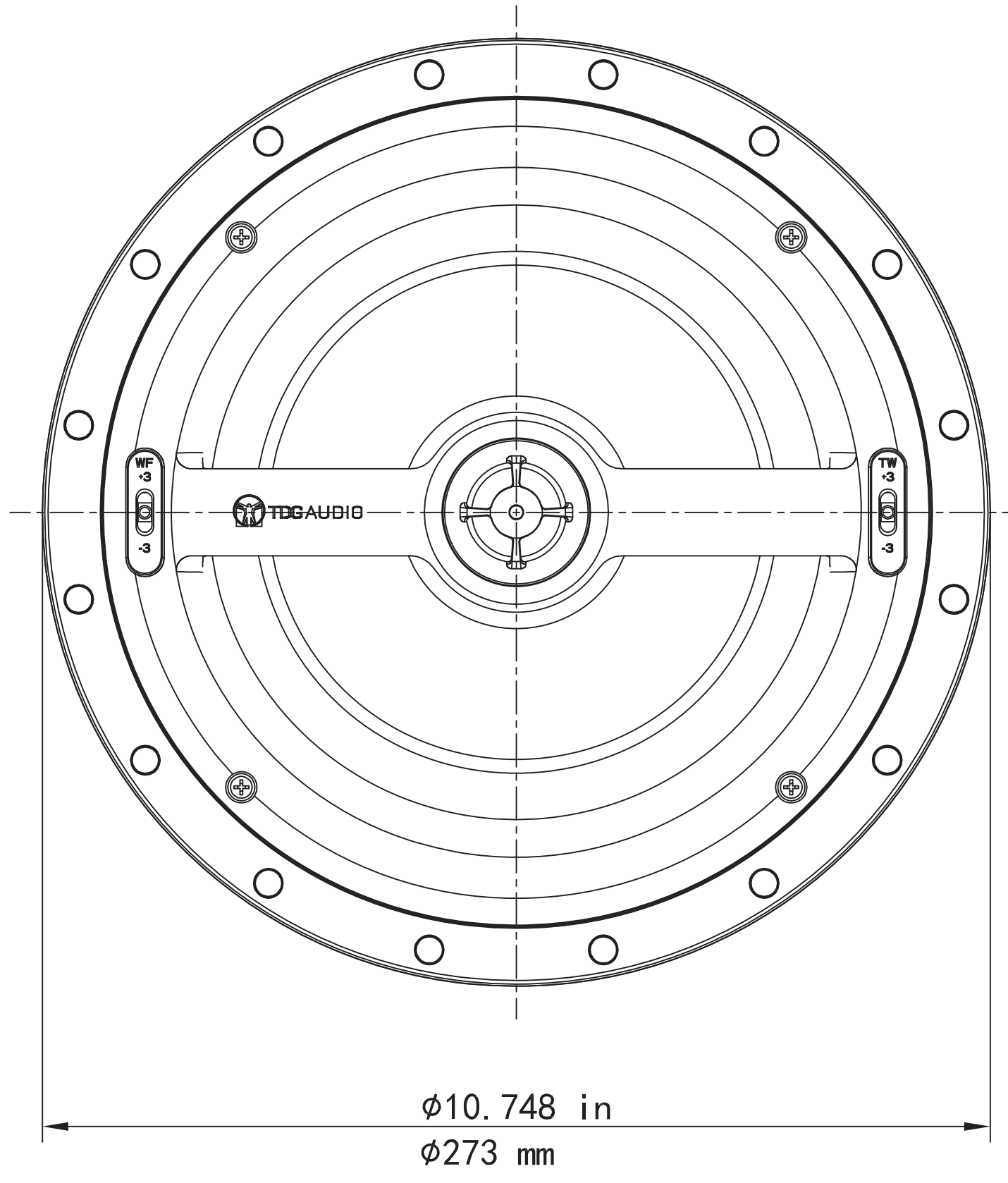

MOUNTING
DEPTH/ MINIMUM
CUTOUT

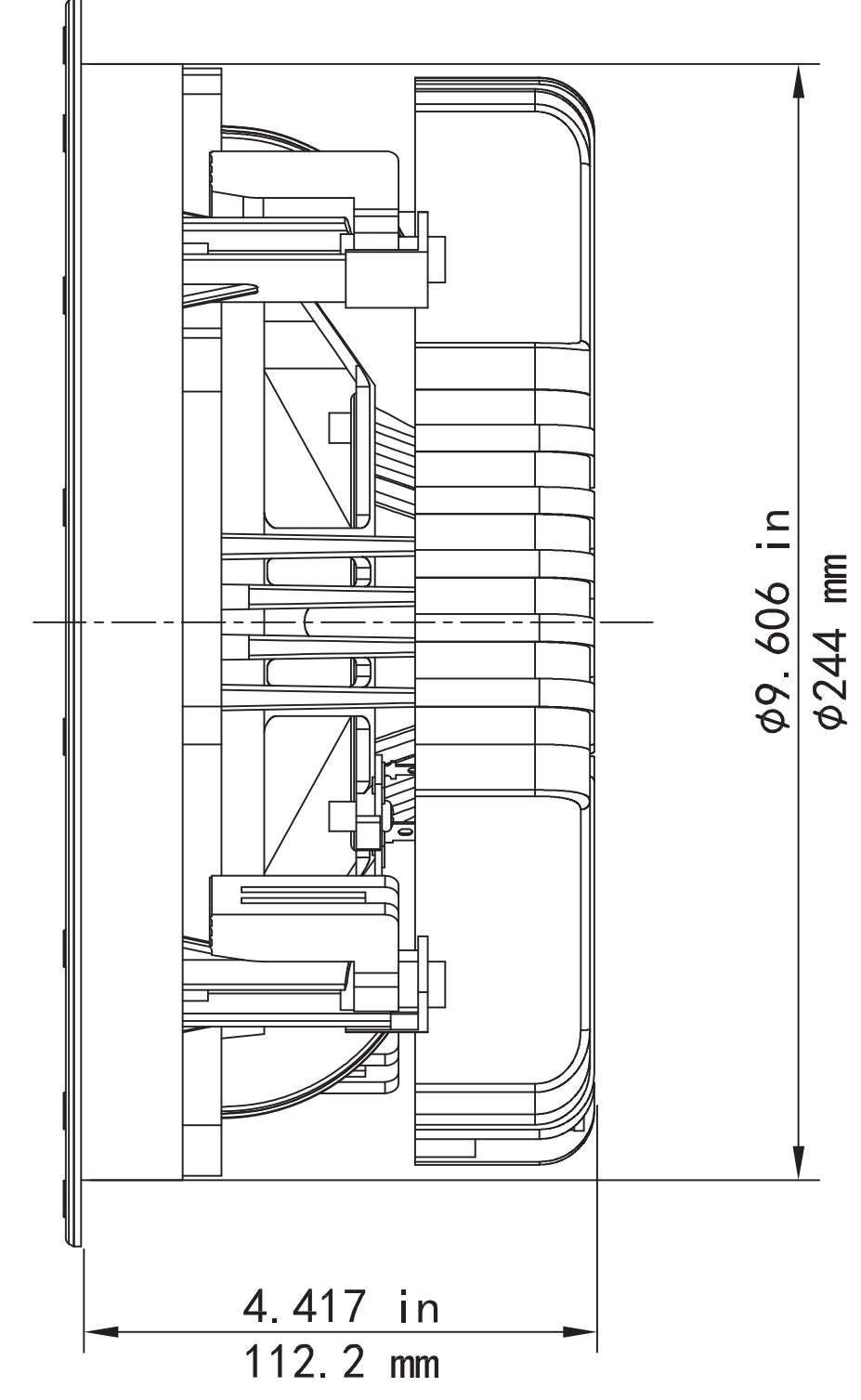

GRILLE

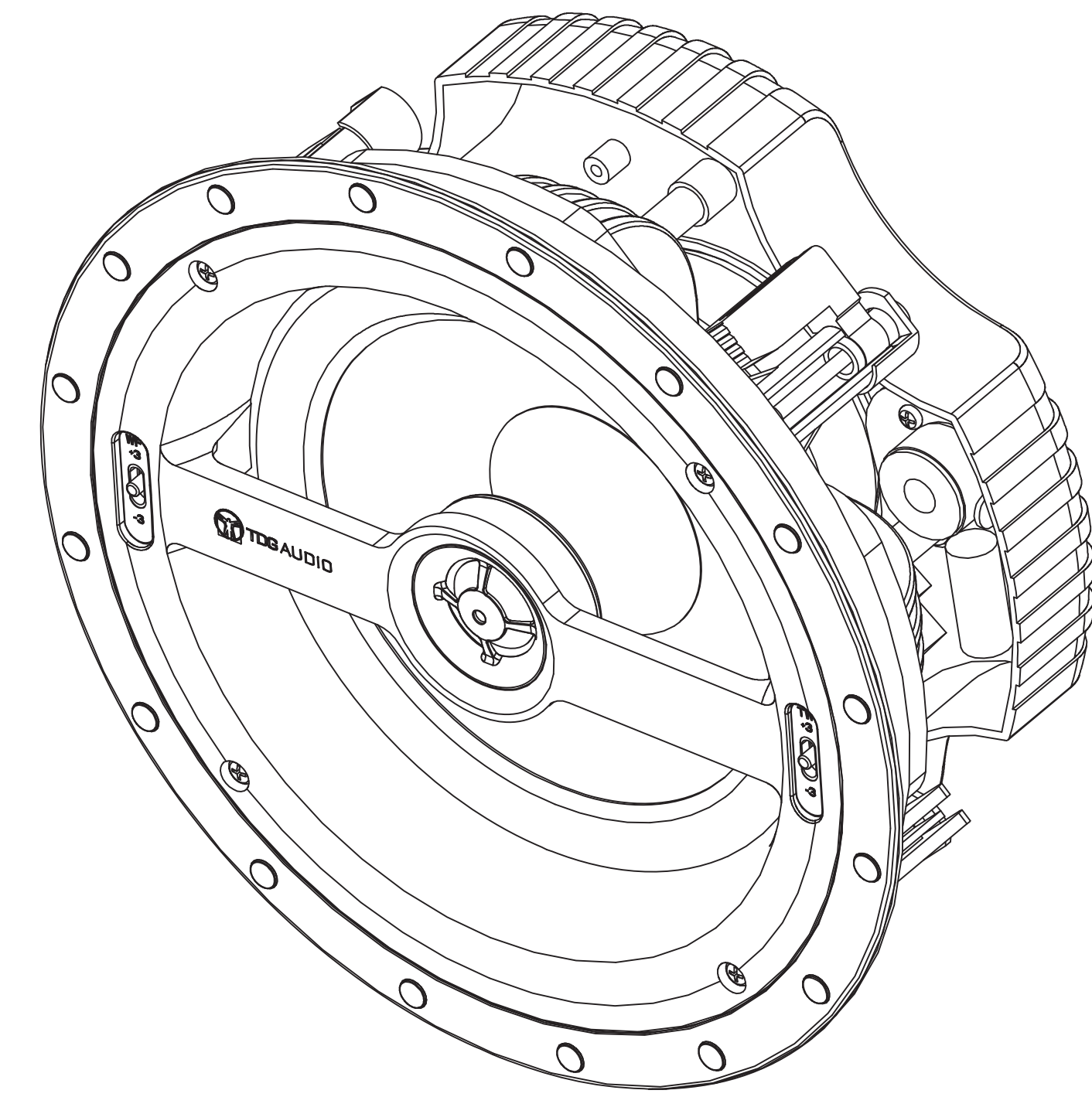
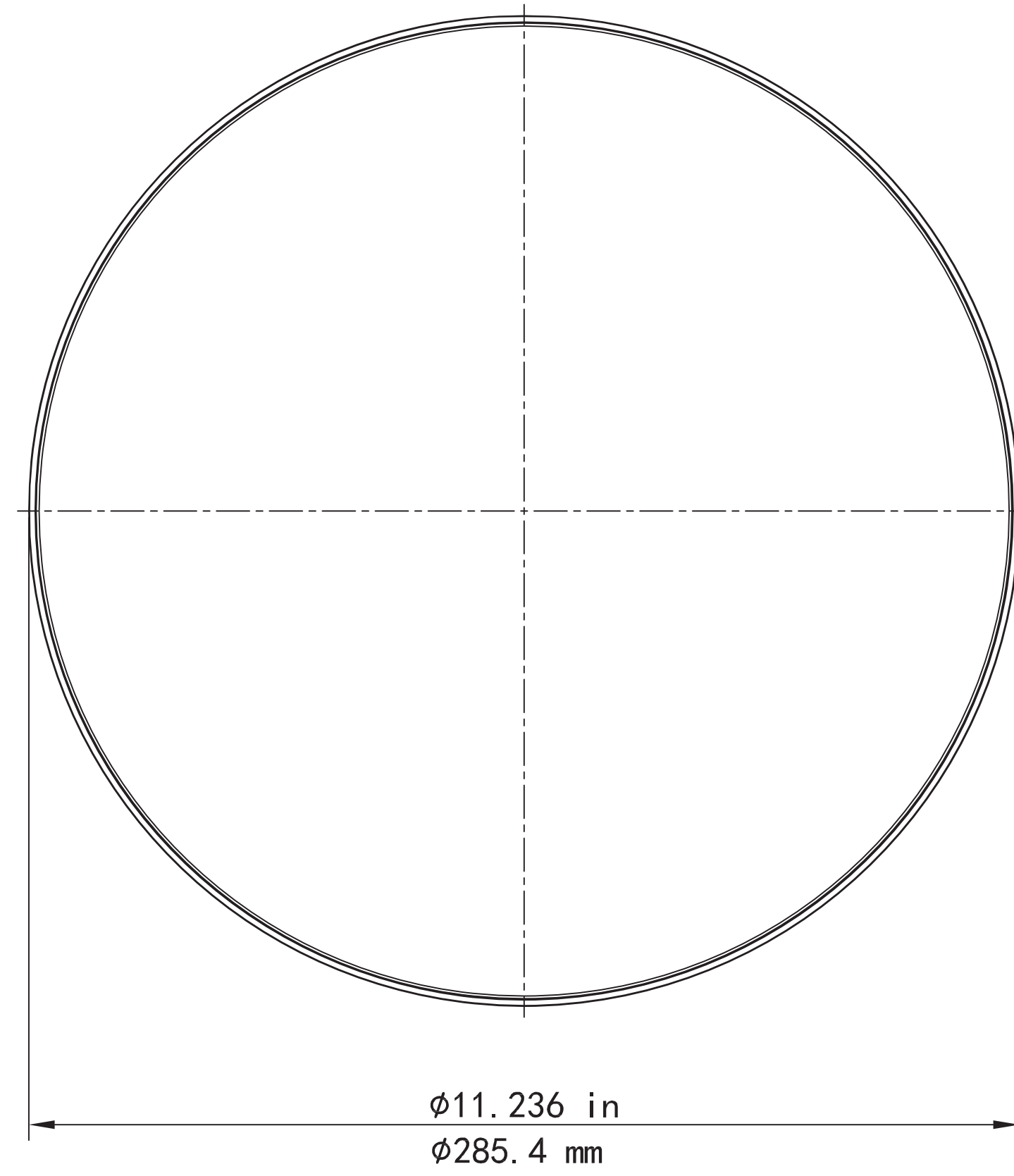

NFC-8 SERIES

SCALE: 1:1	DRAWN BY:	DRWN - PART NUMBER	REV.
SHEET:	OF	RELEASED ON:	

1 (866) TDG 6321 | TDGAUDIO.COM