

CYRUS



CONTENTS

IMPORTANT! READ BEFORE OPERATING THIS EQUIPMENT! ..	1	To play music from a music library on your network.....	13
Power supply	2	Changing tracks.....	13
Note for UK customers	2	Pause.....	13
SERVICING.....	2	To make a new selection.....	13
PRODUCT SERVICE CENTRES.....	2	Favourite tracks.....	13
WELCOME TO THE WORLD OF CYRUS!.....	2	To play Internet radio.....	14
FCC NOTICE.....	3	Saving favourite stations.....	14
Model Features.....	4	Browsing favourite stations.....	14
Key to the rear panel drawing.....	4	To play Online services	14
How does the Stream Xa work?.....	5	Saving favourite stations.....	14
Playing music from a network.....	5	Browsing favourite stations.....	14
Navigating a music library	5	To play a source connected to a digital Aux input	14
Music libraries	5	Digital inputs.....	14
Setting up a network music library	5	To play from a USB source	15
Choosing a file format for your library	5	Playing music from an iPod, iPhone or iPad.....	15
Mixing formats.....	5	Charging an iPod	15
Buying music on-line.....	5	Playing music from a different USB source	15
Further advice on setting up a library	5	SETUP MENU.....	16
SET-UP OPTIONS.....	6	To reach the setup menu	16
Ethernet system with NAS drive - recommended.....	6	Setup - Network Settings - DHCP Settings.....	16
Advantages.....	6	Setup - Network Settings - Status	17
Disadvantages	6	Setup - Network Settings - Internet Test	17
Expansion.....	6	Setup - Input names.....	17
USB music store system - recommended	6	Setup - AUX display mode.....	17
Advantages.....	6	Setup - Used as a source (Setting the MC-BUS	17
Disadvantages	6	response)	17
All-wireless system	7	Setup - Factory Reset	17
Advantages.....	7	Setup - Language.....	18
Disadvantages	7	Setup - About.....	18
INSTALLATION	8	MENU MAP	19
Connecting to a computer network.....	8	TROUBLESHOOTING	20
Wired Ethernet connection.....	8	The Stream Xa will not join a cabled network	20
802.11b/g/n wireless aerial	8	If a wireless network is not visible	20
Connecting digital audio sources.....	9	The network is joined successfully but no UPnP	20
Connecting to the USB port.....	9	music server is found	20
Connecting the fixed analogue outputs to an amplifier	9	USB drive navigation problems	21
Connecting to an AV system	9	USB drive slow navigation.....	21
MC-BUS System	10	Intermittant drop out (silent passages) when playing	21
External Power Supply - PSX-R/PSX-R ₂	10	from a network	21
How it works	10	SPECIFICATIONS.....	22
Connecting to the AC Mains Supply	10	Power supply.....	22
OPERATION	11	Power consumption.....	22
Front panel operation.....	11	Enclosure	22
Power.....	11	Network connectivity.....	22
To switch the unit on from Standby.....	11	Digital audio performance	22
To set the unit to Standby when operational.....	11	Analogue audio performance	22
Selecting a source.....	11	WARRANTY.....	22
Rotary/Push control.....	11	WEEE.....	22
Connecting to a network	12		
Cabled networks	12		
Wireless networks.....	12		
Network not found	12		

IMPORTANT! READ BEFORE OPERATING THIS EQUIPMENT!

CAUTION: The exclamation mark is to draw your attention to important instructions and safety procedures in this manual.



ATTENTION: The lightning flash warns you of the risk of electrical shock presented by components inside this product. Unauthorised personnel must not open this unit.



WARNING: To reduce the risk of electrical shock do not remove any unit covers or panels. There are no user serviceable parts in this product.

WARNING: To reduce the risk of electric shock, do not expose this equipment to rain or moisture.

HEED WARNINGS: All warnings on the product and in the operating instructions should be adhered to.

READ ALL THE INSTRUCTIONS: All the safety and operating instructions should be read before the product is operated.

RETAIN INSTRUCTIONS: The safety and operating instructions should be retained for future reference.

FOLLOW INSTRUCTIONS: All operating and use instructions should be followed.

CLEANING: Unplug this product from the mains before cleaning. Do not use liquid or aerosol cleaners. Use a damp cloth for cleaning.

WATER AND MOISTURE: Do not use this product near water - for example, near a bath tub, wash bowl, kitchen sink, or laundry tub, in a wet basement; or near a swimming pool and the like. The product must not be exposed to dripping or splashing and no objects filled with liquids, such as vases, shall be placed on the product.

HEAT: The product should be situated away from heat sources such as radiators, stoves, or any other products (including amplifiers) that produce heat.

VENTILATION: Slots and openings in the cabinet are provided for ventilation, to ensure reliable operation of the product and to protect it from overheating. These openings must not be blocked or covered. The openings should never be blocked by placing the product on a bed, sofa, rug or similar surface. This product should not be placed in a built-in installation such as a bookcase or rack unless proper ventilation is provided or the manufacturer's instructions have been adhered to.

OBJECT OR LIQUID ENTRY: Never push objects of any kind into this product through openings as they may touch dangerous voltage points or short-out parts that could result in a fire or electric shock.

ACCESSORIES: Do not place this product on an unstable cart, stand, tripod, bracket, or table. The product may fall, causing serious injury to a child or adult, and serious damage to the product. Use only with a cart, stand, tripod, bracket or table recommended by the manufacturer, or sold with the product. Any mounting of the product should follow the manufacturer's instructions, and should use a mounting accessory recommended by the manufacturer.

ATTACHMENTS: Do not use attachments not recommended by the product manufacturer as they may cause hazards.

MOVING THE PRODUCT: A product and cart combination should be moved with care. Sudden stops, excessive force, and uneven surfaces may cause the product and cart to overturn.



POWER SOURCES: This product should be operated only from the type of power source indicated on the marking label. If you are not sure of the type of power supply to your home, consult your product dealer or local power company. For products intended to operate from battery power, or other sources, refer to the operating instructions.

OVERLOADING: Never overload wall outlets, extension cords, or integral convenience receptacles. This can result in an increased risk of fire or electric shock.

POWER CORD PROTECTION: Power supply cords should be routed so that they are not likely to be walked on or pinched by items placed upon or against them, paying particular attention to cords at plugs, convenience receptacles, and the point where they exit from the product.

NAKED FLAMES: No naked flame sources, such as candles, must be placed on this product. Batteries (battery pack or batteries installed) shall not be exposed to excessive heat such as sunshine, fire or the like.

LIGHTNING: For added protection for this product during a lightning storm, or when it is left unattended or unused for long periods of time, unplug it from the wall outlet and disconnect the antenna or cable system. This will prevent damage to the product due to lightning and power-line surges.

BATTERIES: Warning: Batteries shall not be exposed to excessive heat such as sunshine, fire or the like.

CAUTION! POLARISED CONNECTOR (CANADA and USA): To prevent electrical shock, match wide blade of plug to wide slot, fully insert. Do not alter or remove this plug if it does not fit your mains power socket. Have a suitable socket installed by a competent electrician.

ACCESS TO THE MAINS PLUG: The means to disconnect this product from the mains supply is the mains plug. Ensure that the mains plug is accessible at all times.

Power supply

Connect the moulded IEC connector of the AC cord supplied into the power inlet on the rear of the unit.

The mains supply requirement of your unit is marked on a label on the rear panel. Before connecting, check that this voltage is the same as your mains supply.

230V Products: Voltage Range 220V-240V

115V Products: Voltage Range 110V-120V

If you move to an area with a different mains voltage, contact your local Cyrus distributor to have your product converted.

There are no user replaceable fuses in this unit.

Note for UK customers

This product is supplied with a power cable terminated by a fused 13A mains plug. This plug should not be removed but if it is removed, dispose of it safely and do not re-use it. To connect a new 13A plug, proceed as follows: Connect the brown wire to the terminal marked L or coloured red. Connect the blue wire to the terminal marked N or coloured black. Connect the green/yellow wire to the terminal marked E or coloured green. The internal plug fuse should be 5A.

Servicing

Do not attempt to service this product yourself as opening or removing covers may expose you to dangerous voltage or other hazards. Refer all servicing to qualified service personnel.

CONDITIONS REQUIRING SERVICE: Unplug this product from the wall outlet and refer servicing to qualified service personnel when:

- When the power supply cord or plug is damaged.
- If liquid has been spilled, or objects have fallen into the product.
- If the product has been exposed to rain or water.
- If the product has been dropped or damaged in any way.
- If the product does not operate normally by following the operating instructions. (Adjust only those controls that are covered by the operating instructions. Improper adjustment of other controls may result in damage requiring extensive work by a qualified technician to restore the product to its normal operation).
- When the product exhibits a distinct change in performance.

REPLACEMENT PARTS: When replacement parts are required, be sure the service technician has used replacements specified by the manufacturer or have the same characteristics as the original part. Unauthorised substitutions may result in fire, electric shock, or other hazards.

SAFETY CHECK: Upon completion of any service or repairs to this product, ask the service technician to perform safety checks to determine that the product is in proper operating condition.

Product service centres

For product service or technical advice, contact only authorised cyrus service centres. Contact details for cyrus distributors may be found on the cyrus website at www.Cyrusaudio.Com.

WELCOME TO THE WORLD OF CYRUS!

Congratulations on your choice of Cyrus Hi-fi products. Our state-of-the-art design technology and outstanding quality of manufacture has won countless awards around the world. We are confident that you will derive great pleasure from owning a product from one of the most recognised and respected manufacturers of hi-fi equipment.

Now is a good time to register your new Cyrus product. To register, visit www.cyrusaudio.com/support and click the 'Register your product' link.

Please read these instructions carefully before commencing installation. They provide full guidance to help you install your streamer safely and correctly.

FCC NOTICE*

NOTE: This equipment has been tested and found to comply with the limits for a Class B digital device, pursuant to Part 15 of the FCC rules. These limits are designed to provide reasonable protection against harmful interference in a residential installation. This equipment generates, uses and can radiate radio frequency energy and, if not installed and used in accordance with the instructions, may cause harmful interference to radio communications. However, there is no guarantee that interference will not occur in a particular installation. If this equipment does cause harmful interference to radio or television reception, which can be determined by turning the equipment off and on, the user is encouraged to try and correct the interference by one or more of the following measures:

- Reorient or relocate the receiving antenna.
- Increase the separation between the equipment and receiver.
- Connect the equipment into an outlet on a circuit different from that to which the receiver is connected.
- Consult the dealer or an experienced radio/TV technician for help.

Any changes or modifications not expressly approved by the manufacturer could void the user's authority to operate the equipment.

*115V products

Model Features

Cabled or wireless connectivity for your local computer network, enabling you to enjoy music stored on devices connected to the network or Internet radio broadcasts from around the globe.

A USB port to enable playback of music stored on iPods/iPhones or USB devices such as memory sticks, hard drives or personal audio players.

Optical and digital inputs for connection of CD players, DAB radios, digital TV receivers or other sources with SPDIF digital connection.

A digital output for connection to a Cyrus amplifier equipped with digital inputs.

Dual fixed analogue audio outputs for connection to a high-end analogue integrated or preamplifier. A **PSX-R** upgrade connection is also included for the ultimate sound quality.

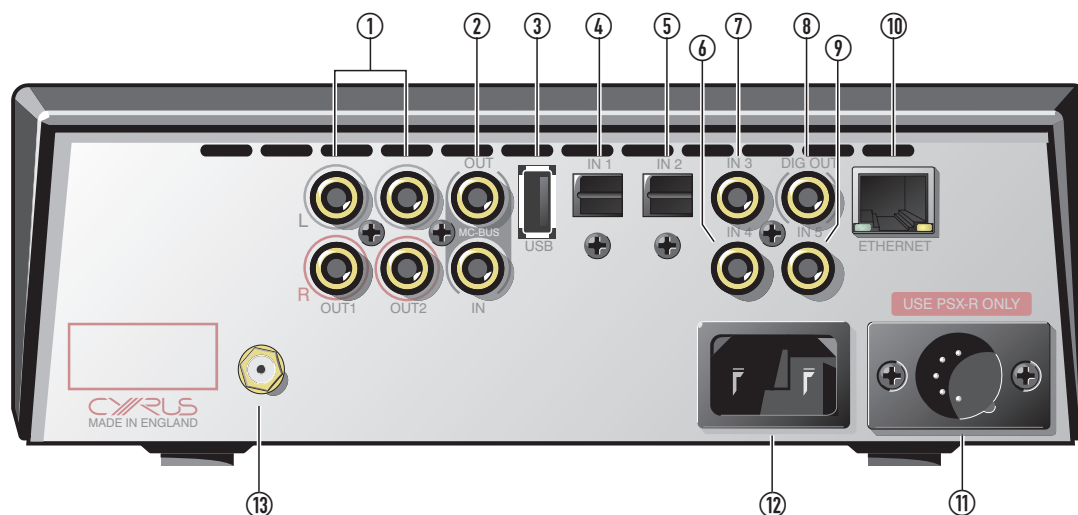

Key to the rear panel drawing

- | | |
|--------------------------------|---|
| 1. Fixed level analogue output | 8. Coaxial digital output |
| 2. MC-BUS connection | 9. Coaxial digital input 5 |
| 3. USB port | 10. Ethernet connection |
| 4. Optical digital input 1 | 11. PSX-R₂ connection |
| 5. Optical digital input 2 | 12. Power inlet |
| 6. Coaxial digital input 4 | 13. Wi-Fi network aerial connector |
| 7. Coaxial digital input 3 | |

How does the Stream Xa work?

The **Stream Xa** joins your computer network in the same way that a computer or other networked device would.

Playing music from a network

Once connected to your network, the **Stream Xa** will identify music libraries present on your network, catalogue the music found in those libraries, and present the library content in a choice of easily searchable categories.

Navigating a music library

In addition to navigation and control from the front panel controls, the Cadence app is available as a free download for iOS or Android mobile phones and tablets. Cadence connects to the **Stream Xa** via the local network and provides an interactive remote control interface that enables a user to browse their music libraries and to control all functions of the **Stream Xa** from the phone/tablet.

Music libraries

Audophile systems have progressed over the years from shelves of fragile vinyl records or magnetic tape to racks of compact discs, played without any physical contact.

Perfect sound forever? Perhaps, but for a serious audiophile a large collection of CDs still occupies a large space in a room, usually in the listening room itself. Cataloguing the CDs can be a chore and remembering which album your favourite tracks are on can be quite a challenge in a large collection of CDs.

The Cyrus **Stream Xa** answers all of these problems, by using computer hardware to take the music content from your discs and store the entire collection in a music library on a hard-drive that occupies little more space than a few CDs.

Setting up a network music library

Choosing a file format for your library

Hard drive size was once a limitation for storage of a high quality, uncompressed music library. This is no longer the case as high capacity hard-drives are now affordable, and multiple drives are also an option.

Lossless formats are also now available, offering the quality of uncompressed files, but with a useful saving of around 40% of the file size.

If you already have an existing library of uncompressed WAV or AIFF files ripped from CD, then this will deliver the highest quality when played through the **Stream Xa**.

If you have an existing library that includes MP3, WMA, AAC or other compressed format files, you may want to consider creating a new library of uncompressed or lossless files from your CD collection. Although the **Stream Xa** is compatible with compressed files, the compression used by these formats to pack the files into a small space removes essential information from the music that cannot be replaced on replay.

The same recommendation applies if you are setting up a new music library for use with your **Stream Xa**. In a new library, uncompressed files carry the highest recommendation.

Mixing formats

The **Stream Xa** will decode most music file types, so it is quite acceptable to retain an existing library of compressed format files, rip new music entries to uncompressed or lossless files and replace the compressed files as time permits.

The **Stream Xa** can also browse multiple libraries, so you may prefer to retain a library of compressed files for portable audio etc., and set up a new library of uncompressed or lossless music for the **Stream Xa**.

Buying music on-line

There are currently few sources on-line for the purchase of high quality uncompressed or lossless files. To achieve the best quality for your music library, rip your music from CD to uncompressed or lossless files.

Further advice on setting up a library

A good retailer can advise on setting up a library of music files for use with the **Stream Xa**.

SET-UP OPTIONS

The **Stream Xa** is extremely versatile and can be incorporated into your music world in many different ways. This page shows two configurations recommended by Cyrus, and one that is not recommended.

The systems are illustrated as guidelines only to help you plan the best way to install your **Stream Xa**.

Your retailer will have been trained to provide you expert advice to find the optimum setup for your **Stream Xa** system.

Ethernet system with NAS drive - recommended

This is the optimal **Stream Xa** system. In this system all network connections are cabled and the music library is contained on a NAS drive, located near the **Stream Xa**. The network switch, placed near the **Stream Xa**, provides local connection between the **Stream Xa** and the NAS drive for fastest possible data transfer. The network switch links to the router to enable Internet Radio functions and music transfer between the computer and the NAS drive.

This system carries the strongest recommendation from Cyrus.

Advantages

- Robust wired connection between network components.
- Easy navigation of music content.
- Music is added to the library on the NAS drive from the computer through the network.
- Internet radio reception is possible.

Disadvantages

- None.

Expansion

- Other sources and USB devices may also be connected to the **Stream Xa**.

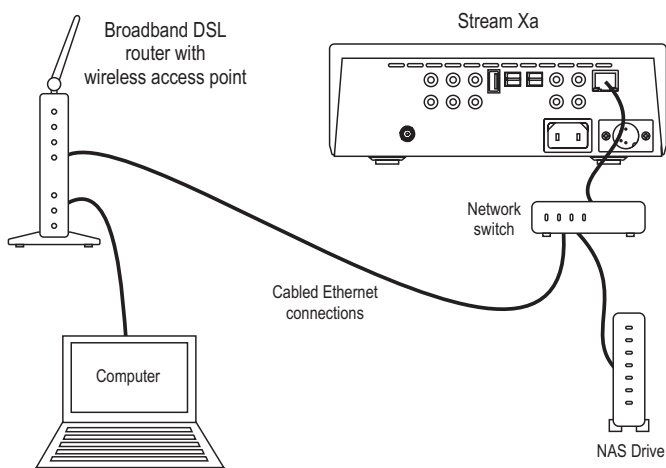

USB music store system - recommended

This is the simplest **Stream Xa** system.

Advantages

- Extremely simple to set up.
- Does not require a computer to function.

NOTE: A network connection is required to enable Internet Radio reception and remote control via the Cadence app.

Disadvantages

- Library navigation is by folder on the hard drive.
- The hard drive must be re-connected to a computer when you want to add music to the library.

NOTE: A hard drive connected via the USB port should be no larger than 500GB and must be formatted as FAT16 or FAT32 only.

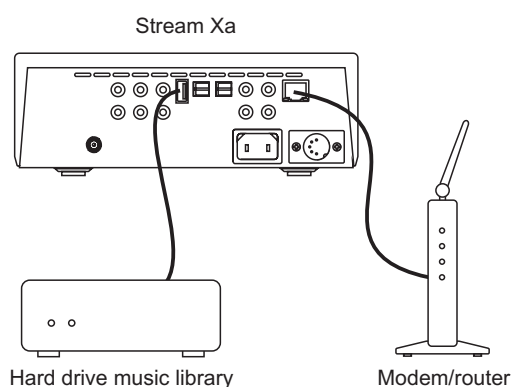

All-wireless system

Although Cyrus wi-fi technology can provide a really easy installation solution, wireless transfer can be affected by the building and other wi-fi equipment, Therefore, where possible, a wired installation is recommended for the best transfer of large files.

Advantages

- Looks simple to install.

Disadvantages

- Lower quality connection between networked components.
- Installation and configuration of UPnP server software on each network computer will be necessary to permit access to the music library.
- Music is only available to the **Stream Xa** when the computer(s) containing the music library are switched on.

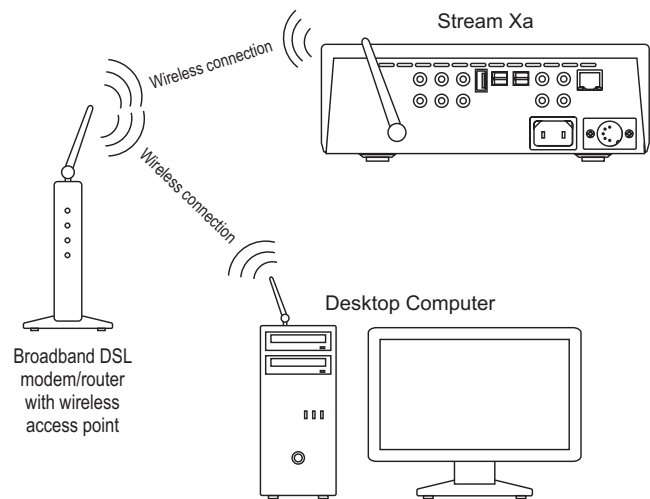

INSTALLATION

Before installing your Cyrus **Stream Xa** check that the following items are included in the accessory box.

- Power cable
- Wi-Fi aerial
- 1m Ethernet cable
- 2 x cables for MC-BUS connection
- Handbook CD-ROM
- Ferrite clamp with cable tie (for Ethernet cable)

After removing these items, please retain the packaging.

Install the unit in a well ventilated location away from sources of high temperature, dust or humidity. Never stand the unit under another unit or on any surface likely to obstruct its cooling or ventilation.

IMPORTANT NOTE – READ BEFORE MAKING ANY CONNECTIONS

To avoid possible damage to your unit, it is essential to disconnect all system components from the mains supply before connecting or disconnecting any interconnects.

Connecting to a computer network

There are two network connection options, ethernet cable connection or 802.11b/g/n wireless. If the **Stream Xa** detects an ethernet cabled connection, this will be used in preference to a wireless connection.

Where possible, ethernet cable connection to the **Stream Xa** is strongly recommended as this enables a far higher data bandwidth than wireless connection.

Wired Ethernet connection

The **Stream Xa** is supplied with a 1m length Ethernet cable. If this cable is not suitable for your installation, pre-assembled Ethernet cables of the correct length are readily available. Measure the distance that the cable will run between the **Stream Xa** and a spare connection on the router/switch, or if the building is pre-wired with ethernet cable, to the nearest ethernet socket on the wall. Obtain an ethernet cable of at least this length.

- Fit the ferrite clamp and tie wrap (supplied) to the cable as shown below.

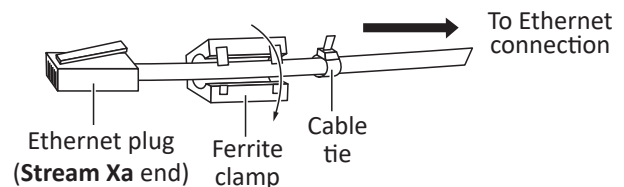

*The cable tie is used to retain the clamp close to the plug connected to the **Stream Xa**.*

- With the clamp fitted, connect this end to the ethernet socket on the **Stream Xa**.

The plug will latch into place.

- Connect the other end to the modem/router or wall socket.

Ethernet wired connection is very robust and will run over distances of 50m or more without requiring a repeater.

802.11b/g/n wireless aerial

If you are connecting the **Stream Xa** to the network via 802.11b/g/n wireless, you will need to fit the wireless aerial to the **Stream Xa**.

- Screw the aerial directly onto the Wi-Fi aerial network connector on the back panel.

The aerial should be aligned vertically for best results.

Connecting digital audio sources

The digital audio inputs are compatible with a number of different digital audio sources. These include-

- Digital Audio output from a CD player
- Digital Radio
- Blu-ray/DVD players (for replay of 2 channel PCM programs only)
- Digital Satellite receivers (for replay of 2 channel PCM programs only)
- Games Console

Using a suitable Toslink optical or a digital phono interconnect, connect each digital audio source to one of the inputs 1-5. Make a note of the input number used for each source as the inputs can be re-named at the set-up stage.

Connecting to the USB port

The USB port is compatible with iPods, iPhones, iPads and other personal audio players, also memory sticks, hard drives and personal audio players. It is **not** intended for connection to the USB port of a computer.

NOTE: If you are connecting a USB flash drive or hard drive, make sure that the drive is no larger than 500GB and formatted as FAT16 or FAT32. Larger drives may be slow to navigate and other formats such as NTFS will not be navigable from the **Stream Xa**. If you prefer to use a larger drive, a NAS drive connected via your computer network is highly recommended.

As the USB port is located on the back panel of the unit, you may want to leave a docking cable for your personal audio player permanently connected and accessible from the front of the unit.

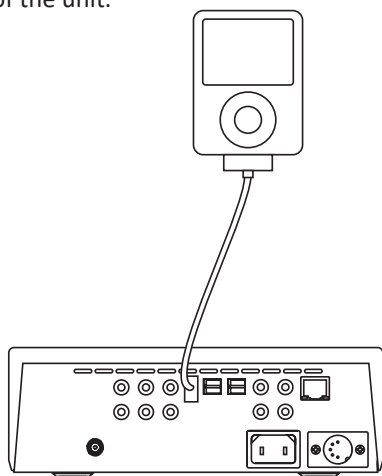

If your personal audio player has an integrated USB connector, a plug to socket USB extension cable will extend the docking connector to an accessible place.

Connecting the fixed analogue outputs to an amplifier

The **Stream Xa**, may be connected to the analogue inputs of an integrated or pre-amplifier.

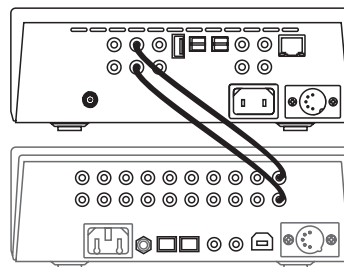

If you are connecting the **Stream Xa** to an amplifier (or preamplifier) with volume control, use a suitable audio interconnect to connect the Fixed Out sockets to a spare analogue input of the amplifier.

NOTE: The **Stream Xa** features dual fixed outputs labelled OUT1 and OUT2. Either or both of these may be connected to an integrated or pre-amplifier input.

NOTE: The **Stream Xa** does not include a preamplifier output so must not be connected directly to a power amplifier.

Connecting to an AV system

The **Stream Xa** should be connected as a digital source component of an AV system. Follow the instructions in the previous section to connect the digital output of the **Stream Xa** to a digital input of the AV system.

MC-BUS System

Connecting the MC-BUS sockets in an MC-BUS system provides unified system control. An MC-BUS loop is established by connecting single phono cables from the MC-BUS output of one unit to the MC-BUS input of another in a daisy-chain. Complete the loop by returning the MC-BUS output of the final component to the MC-BUS input of the first.

If the **Stream Xa** is connected as a source of an amplifier, its MC-BUS response can be set so that the system amplifier will switch the **Stream Xa** to and from Standby.

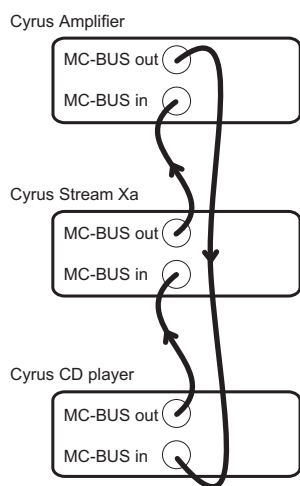

External Power Supply - PSX-R/PSX-R₂

The **PSX-R** is a unique DC power supply that will upgrade the sonic performance of compatible products in the Cyrus range. The **PSX-R₂** is a performance upgraded version of the **PSX-R**. Both of these power supplies are compatible for connection to the **Stream Xa**.

The following text refers to the use of the **PSX-R**, but applies also to the **PSX-R₂**.

To connect a **PSX-R**, disconnect both components from the mains, then plug the connector on the umbilical cord of the **PSX-R** into the Multi-Pole socket on the back panel. You will need a mains supply for both units.

NOTE: Connection of a **PSX-R** is detected automatically, so no internal adjustments are required.

How it works

When a **PSX-R** is connected to a Cyrus product, the power feeds to the internal circuitry are split two ways with the clean, stable power source of the **PSX-R** feeding sensitive circuit sections while other requirements are supplied internally. This ensures complete isolation of control circuits and sensitive analogue sections reducing AC mains-borne noise and power supply ripple.

Connecting to the AC Mains Supply

Connect the socket on the AC Power cable to the Power inlet on the rear panel of the unit. Now connect the cable to a suitable AC power point.

OPERATION

The **Stream Xa** is an extremely powerful and versatile audio streamer.

When using a newly installed **Stream Xa** for the first time, the following procedure is highly recommended -

- Follow the instructions for front panel operation in the next section until you are satisfied that the **Stream Xa** is set up as you would like it, and you have an understanding of basic operation.

- Download and install the Cadence app on a compatible iOS or Android device.
- Learn how to make the most of Cadence when operating your **Stream Xa** and other system components.

If you encounter any problems during the initial setup of your **Stream Xa**, refer to the Troubleshooting section (see page 20).

Front panel operation



- | | |
|----------------------------|---------------------------|
| 1. Mute key | 8. Back key |
| 2. Standby key | 9. Next key |
| 3. Standby Indicator | 10. Previous key |
| 4. Headphone key | 11. Play/Pause key |
| 5. Remote control receiver | 12. AUX input select |
| 6. Display window | 13. Internet Radio select |
| 7. Rotary/Push control | 14. Network music select |

Power

When power is applied, the STANDBY key is used for power control.

To switch the unit on from Standby

- Press the STANDBY key.

The unit will switch on and the Standby Indicator will change to green.

To set the unit to Standby when operational

- Press the STANDBY key.

The unit will set to Standby and the Standby Indicator will change to orange.

The unit will now check if an iPod is connected to the USB connector. If so, the iPod will be charged and the indicator will remain orange (charging) until the iPod is disconnected.

If no iPod is connected, full Standby will be set after a short delay.

In full Standby mode, the Standby Indicator will change to red.

In regular use the unit should be connected permanently to the mains power supply. When left unattended for a long period (holidays etc) it should be disconnected from the AC supply.

When switched to Standby, or if disconnected from the mains, network settings and settings for input selection and Volume/Balance are retained.

Selecting a source

- Press the MUSIC Key to listen to music from a music library located on a networked computer or drive.
- Press the RADIO key to listen to Internet Radio.
- Press the AUX key repeatedly to step through AUX sources 1 to 5 and also the USB source.

Rotary/Push control

- Turn the Rotary/Push control to scroll through the options available on the display.
- Press the Rotary/Push control to select the option displayed next to the cursor.
- Press the \leftarrow key to move back through the menus.

NOTE: Press and hold the \leftarrow key to return to the Main Menu at any time.

Connecting to a network

When switched on, the **Stream Xa** logo and a progress bar are displayed while the unit searches for a network.

Cabled networks

When available, a cabled network connection will always take connection priority over a wireless connection. If a cabled connection is detected, the **Stream Xa** will join the network automatically*.

The Source Menu will be displayed (jump to the next column).



*If the **Stream Xa** does not join your network automatically, refer to the troubleshooting section before proceeding.

Wireless networks

If no cabled network is found, and the aerial is connected, a list of the wireless network names (SSIDs) in range will be displayed with signal strength indication.

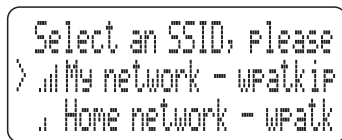

NOTE: **Stream Xa** will only find a wireless network with SSID broadcast enabled.

- Turn the Rotary/Push control to position the network you want to join next to the cursor.
- Press the Rotary/Push control to select the network. If you select the wrong network, press the \leftarrow key to return to the network list.

If the wireless network requires a security password, the display will prompt for password entry.

- Press the \triangleright or \triangleleft key repeatedly to switch character set entry between -
 - Numeric entry
 - Lower case alphabet
 - Upper case alphabet
 - Punctuation and other symbols
 - OK (select this option when you have finished entering the password).
 - Space (select this option to enter a space in the password)
 - Delete (select this option to delete the last character you entered).
- Turn the Rotary/Push control to change the character displayed.
- Press the Rotary/Push control to add each character to the password displayed.

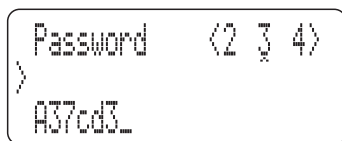

- When you have completed password entry, select the 'OK' option from the list above.

The system will then restart. The Source Menu menu will be displayed following successful connection.

Network not found

If no cabled network was detected and there are no wireless networks in range, the Network Error menu will be displayed.



- Select 'Use without network' if you don't require a network connection.

Without a network connection, Aux and USB inputs may be used and the **Stream Xa** can be operated from the front panel controls.

Network music, internet radio and remote control from the Cadence app will only be available when the **Stream Xa** is connected to a network.

- Select 'Wireless Wizard' to search again.

NOTE: If the **Stream Xa** does not list your wireless network, refer to the Troubleshooting section.

To play music from a music library on your network

- Press the MUSIC key.

You can now browse a list of the UPnP music servers on your network.

*NOTE: If your server is not listed, refer to the Troubleshooting section.

- Turn the Rotary/Push control to position the server you want to use next to the cursor.

```
Audio Server
>Asset UPnP:MyMusic
UPnP Server:4761
```

- Press the Rotary/Push control to select this server.

You can now choose how to browse your music. The browsing options you see will be those offered by the server you selected, but will typically allow browsing by album, artist, genre, playlist etc.

```
Asset UPnP:MyMusic
>Album
Artist
```

- Turn the Rotary/Push control to position the category you want to select next to the cursor.
- Press the Rotary/Push control to select this category.

You can continue to browse and select sub-category options in the same way. For example, the Genre category may include sub-categories for Blues, Classical, Country etc.

- When you reach the music selection you want to play (this may be an album, a track or a complete category - for example, the Blues Genre), press the  || key.



```
1 Release the Pressure
Leftfield - Leftism
```

After a short delay the light above the  || key will change from red to green and the music will start to play. A progress bar showing elapsed time will be displayed above information retrieved from the library about the track playing, artist etc.



NOTE: Track information will only be displayed if it is available from the server for the track playing (for example, the ID3 tag of a FLAC file).

Music will continue to play until all tracks in the selection have played. If a single track is selected, play will continue through the album containing the selected track. At the end of the selection, play will stop and the light above the  || key will change to red.

Changing tracks

- To change track, press the  | or |  key to select the next or previous track in the selection.

Pause

- To pause playback at any time, press the  || key. Playback will pause and the light above the  || key will change to yellow.

- Press the  || key again to re-start play.

To make a new selection

- Press the  key to step back through the categories and make a new selection.

Favourite tracks

Your **Stream Xa** can memorise a list of favourite tracks. Using the Cadence app you can save your favourite tracks to the favourites list as they play. You can then browse your favourite tracks from the Cadence app or from the front panel controls.



NOTE: Favourite tracks can only be stored from a network music library (not from a USB drive or iPod source) up to a maximum number of 250 entries.

To play Internet radio

NOTE: To receive Internet Radio, the **Stream Xa** must be connected to the Internet through a network.

- Press the RADIO key.

After a short delay, the Internet Radio categories are displayed. Choose from the options available to locate the station you want to listen to. The filter option will enable you to search by location (country), language, genre etc.

- While listening to Internet Radio, you can step through the stations in the current station list by pressing the  or  key.

Saving favourite stations

Favourite stations are similar to radio presets and are stored in the same way as favourite tracks, using the Cadence app for mobile devices.

Browsing favourite stations

Once you have saved your favourite stations, you can browse the list of favourites from the Cadence app or front panel display.

- Navigate to the Radio menu.
- Choose the 'Favorites' option.

A list of saved favourite stations will be displayed.

To play Online services

NOTE: To play Online services, the **Stream Xa** must be connected to the Internet through a network.

- Navigate to the Source menu.
- Select the 'Online services' option.

After a short delay, available Online services categories are displayed. Choose from the options available to locate the service you want to listen to.

NOTE: The TIDAL option will give access to the TIDAL online catalogue of high resolution audio files.

Paid subscription will be required to enable the TIDAL service. You can subscribe from the TIDAL app on a mobile device or by visiting the TIDAL website.

Once you have a TIDAL login you can enter this using the Cadence app to enable the TIDAL service on your **Stream Xa**.

Saving favourite stations

Favourite stations are similar to radio presets and are stored in the same way as favourite tracks, using the Cadence app for mobile devices.

Browsing favourite stations

Once you have saved your favourite stations, you can browse the list of favourites from the Cadence app or front panel display.

To play a source connected to a digital Aux input

- Press the AUX key repeatedly to step through the 5 Digital Audio sources available from the **Stream Xa**.

Digital inputs

- Choose Inputs 1 to 5 to select sources such as CD players, DAB tuners etc that you have connected to the Digital Inputs 1 to 5 on the back panel.

You can now set the source to play.

- Set the volume with the Volume/Source control.

NOTE: You can rename any of the AUX inputs to match the source connected. For example, you can rename the USB input to 'iPod' if you connect an iPod to it. Refer to the **Stream Xa** Setup Menu section for input renaming instructions.

To play from a USB source

- Press the AUX key repeatedly to select USB.

Playing music from an iPod, iPhone or iPad

If you have connected an iPod, you can now browse the music selection categories such as Playlists, Artists, Albums etc,

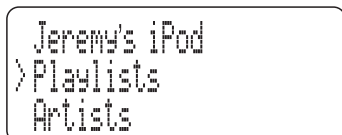

- Navigate to the category you want.
- Continue to navigate through the iPod categories to find the music selection you want to play. This may be a track, album, playlist or a complete genre.
- Press the $\blacktriangle \parallel$ key to play the selection.

After a short delay the play light above the key will change from red to green and the music will start to play. A progress bar showing elapsed time will be displayed above information retrieved from the library about the track playing, artist etc.

Track selection and pause functions are selected in the same way as music play from a network.

NOTE: Track, artist and album information will only be displayed if it is available from the iPod for the track playing.

Music will continue to play until all tracks in the selection have played. If a single track is selected, play will continue through the album containing the selected track. At the end of the selection, play will stop and the play light will change to red.

Charging an iPod

An iPod connected to the USB socket will charge when the unit is operational (but not in full Standby).

Playing music from a different USB source

If a memory stick, hard drive or personal audio players is connected to the USB socket, you will be able to browse the folders on the drive in the same way that you would browse them from a computer.

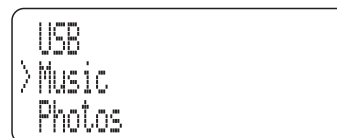

As shown in the example above, all folders will be displayed (not just those with music content).

- Navigate to the folder where your music is stored.
- Continue to navigate through the folders to find the music selection you want to play.
- Press the $\blacktriangle \parallel$ key to play the selection.

After a short delay the play light above the key will change from red to green and the music will start to play. A progress bar showing elapsed time will be displayed above information retrieved from the file about the track playing, artist etc.

Track selection and pause functions are selected in the same way as music play from a network.

NOTE: Track, artist and album information will only be displayed if it is available for the track playing.

Music will continue to play until all tracks in the selection have played. If a single track is selected, play will continue through the folder containing the selected track. At the end of the selection, play will stop and the play light will change to red.

SETUP MENU

The Setup menu enables you to change settings of your **Stream Xa** to best match your system and listening preferences.

To reach the setup menu

- Press and hold the  key to return to the Main Menu.
- Select the Setup option from the Main Menu.

The setup menu will open and the sub-options will be displayed.

Setup - Network Settings - DHCP Settings

The factory default network settings of the **Stream Xa** (DHCP enabled) should be compatible with most modern cabled or wireless networks.

It should not therefore be necessary to change the network settings of a **Stream Xa** unit, unless you know that your network has been configured to require Manual IP addresses.

If this is the case, you should only proceed to change the network settings if you fully understand Manual IP address assignment, and know a free IP address that can be allocated to the **Stream Xa**. Assigning an existing IP address to the **Stream Xa** may cause conflicts with other network devices.

NOTE: These settings can only be changed from the front panel controls.

- Select the Network Settings option from the Setup menu.

The Network Menu will be displayed. The DHCP Settings option

- Select the DHCP Settings option from the Network Settings menu.

The DHCP menu will be displayed.

- Select the 'Off' option to change to manual IP assignment.
- Enter the IP address in the format nnn.nnn.nnn.nnn using the keys listed to follow.
- Press the  || key repeatedly to switch character set entry between
 - Numeric entry
 - Lower case alphabet
 - Upper case alphabet
 - Punctuation and other symbols
 - OK (select this option when you have finished entering the IP address).
 - Space.
 - Delete (select this option to delete the last character you entered).
- Turn the Volume/select control to change the character displayed.
- Press the Volume/select control to add each character to the address displayed.
- When you have completed entry of the IP address, select the 'OK' option from the list above.

The display will now prompt for a Subnet Mask.

- Follow the same procedure to enter the Subnet Mask in the same format.

The display will now prompt for a Gateway address.

- Follow the same procedure to enter the Gateway address in the same format.

The display will now prompt for a DNS1 address.

- Follow the same procedure to enter the DNS1 address in the same format.

The display will now prompt for a DNS2 address.

- If you want to enter a DNS2 address, follow the same procedure to enter the DNS2 address in the same format.
- If you don't want to enter a DNS2 address, select 'OK' to bypass this setting.

*Once the last entry is completed, the **Stream Xa** will re-start and join the network using these settings.*

NOTE: If a **Stream Xa** set to Manual IP is connected to a different network these settings must be changed, or DHCP re-enabled, depending on the network requirements.

Setup - Network Settings - Status

Select the Status option from the Network menu to display the current network configuration information. This may be helpful diagnostic information if network connection problems are encountered.

Setup - Network Settings - Internet Test

Select the Internet Test option from the Network Menu to check that the **Stream Xa** is connected to the Internet for reception of Internet Radio broadcasts etc. After a short delay the test will confirm if the Internet is connected.

Setup - Input names

When the **Stream Xa** leaves the factory, the default input names are set to correspond to the rear panel connections, for example Input 1 will display as- Input 1.

If you prefer, the name of any AUX input (including USB) may be changed to a choice from the following list-

CD, DAB, Satellite, Cable, TV, iPod, MP3, DVD, BluRay, CD1, DVD1, SACD, AV, PVR, Games Console, PC, Laptop, MAC, Special, Keyboard, Aux , AV Direct*.

*Setting the AV Direct input name will fix the volume control to -6dB when this input is selected, enabling the **Stream Xa** to emulate a power amplifier for AV systems etc. Only select this input name if you fully understand the use of a **Stream Xa** to emulate a power amplifier.

To change the names of the inputs, we recommend making a list of each input number with your preferred name from the choices above before setting the names.

- Select the Input Names option from the Setup menu.

The current input names will be listed.

- Select the input name that you want to change.

You can now browse the list of available names.

- Select the new name for this input.

The input will be renamed.

- You can continue to rename other inputs if required.

NOTE: Aux inputs that have been removed from the list can be re-instated by naming them or by selecting the input number from the list.

Setup - AUX display mode

This option changes the presentation of the front panel display when playing an AUX source.

Select 'Large Input Name' to display a large text input name and a volume bargraph.

Select 'Sample Rate' to reduce the size of the input name and add a sample rate display.

Setup - Used as a source (Setting the MC-BUS response)

- Select the 'Used as a source' option to change the MC-BUS response.

*You now have the option to select the amplifier input that the **Stream Xa** is connected to.*

- Choose from CD, Tuner, AV or Stream X.

*When this selection has been made, the **Stream Xa** will switch on when the chosen input is selected at the amplifier.*

Setup - Factory Reset

The factory reset option will reset all settings to 'factory original'.

NOTE: All settings will be reset including network settings, input names, etc.

- Select the Factory reset option from the Setup menu.

A confirmation prompt is displayed.

- Choose 'Yes' if you want to proceed with a reset.

All stored settings will be erased when the unit is next set to Standby.

Setup - Language

You can change the Language for the **Stream Xa** display menus.

- Select the Language option from the Setup menu.

The languages available will be listed.

- Select your preferred language.

The menu language will change.

NOTE: The language of albums, titles and artists etc will not be changed with the language setting. The **Stream Xa** will always display this information in the language stored with the music file.

Setup - About

Choose this option to display information about the firmware installed in the **Stream Xa**. You may be asked for this information if you contact Cyrus for service or support of your system at any time.

MENU MAP

A full menu map for the Stream Xa is shown below, including both source selection and setup options.

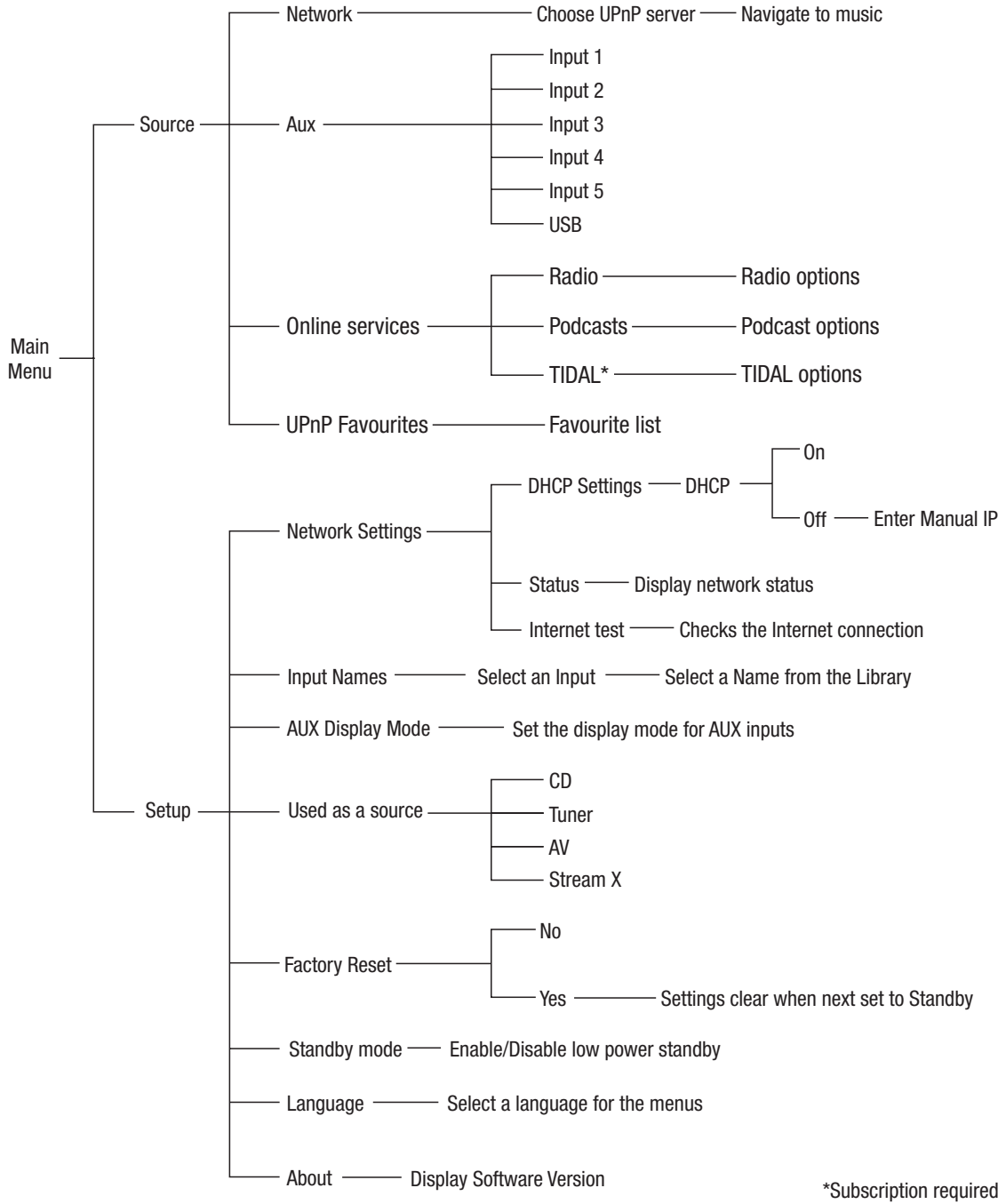

TROUBLESHOOTING

The Stream Xa will not join a cabled network

If the **Stream Xa** is connected to a cabled network that includes a working computer, but the network is not found by the **Stream Xa**:

- Temporarily disconnect the ethernet cable from the computer and connect it to the **Stream Xa**.

*If the **Stream Xa** now connects to the network successfully, it may be that there is a fault with the cabling of the **Stream Xa** installation.*

If the above test proves that the computer will connect to the network, but not the **Stream Xa**, follow these steps to check that DHCP is set on:

- Press and hold the  key to return to the Main Menu.
- Select the Setup option.
- Select the Network Settings option.
- Select the DHCP Settings option.
- Confirm that the 'On' option is checked under the DHCP heading. If not, change the setting to 'On' and re-try connecting to the network.

```

DHCP
>On
  Off
  
```

If DHCP is already set on, then it is probable that your network is set for manual assignment of IP addresses, and it will be necessary to assign an IP address to the **Stream Xa** manually. This should only be attempted if you fully understand manual IP address assignment and have access to a range of free IP addresses that can be assigned to the **Stream Xa**. Refer to the Setup - Network section on page 16 for full instructions to set a manual IP address.

If you suspect that the network is configured for manual assignment of IP addresses, but don't have the knowledge or information necessary to assign an address manually, enlist the help of an IT Professional.

If a wireless network is not visible

If the **Stream Xa** does not display your wireless network in the network list, or if no wireless networks are found:

- Check that an aerial is fitted to the wireless network aerial connector on the back panel.
- Move the **Stream Xa** very close to the source of your wireless network (usually the modem/router).
- Re-connect the power and check if your network is found.

*If the **Stream Xa** connects successfully when moved close to the wireless source, there may be inadequate signal strength in the original location. Experiment with different positions to improve signal strength, or install an ethernet cable which will always give better results than wireless.*

If the wireless network is still not visible when the **Stream Xa** is placed close to the wireless source, it may be that the SSID (network name) of your wireless network is hidden. The **Stream Xa** will not find a wireless network with a hidden SSID, so it will be necessary to re-configure the source of your wireless network (usually the modem/router) so that the SSID is visible. If you are not sure how to make these changes, enlist the help of an IT professional.

The network is joined successfully but no UPnP music server is found

In this case, this screen will be displayed.

```

Audio Server
>---- empty ----
  
```

It is possible that the UPnP server software installed on your computer may require you to enable library sharing for the **Stream Xa**.

The exact procedure to change library sharing will depend on the UPnP server software, but you will generally need to open the 'options' or 'preferences' section within the UPnP server software, locate the section for 'Sharing' and enable sharing for your preference of all devices, or just the **Stream Xa**.

Once the settings are saved you should be able to find the server at the **Stream Xa**.

USB drive navigation problems

When selecting a drive connected to the USB port, the message Unable To Browse is displayed.

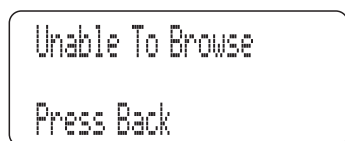

This message will be displayed if the format of the connected drive is not compatible with the **Stream Xa**. In this case, the drive should be formatted as FAT16 or FAT32.

NOTE: Re-formatting the drive will erase all data contained on the drive.

USB drive slow navigation

Check the size of the drive. A maximum drive size of 500GB is recommended when connected to the USB port to ensure fast navigation. If you prefer to use a larger drive, a NAS drive connected via your computer network is highly recommended.

Intermittant drop out (silent passages) when playing from a network

This is most likely to be caused by inadequate network bandwidth.

If you are using a wireless network, it is probable that the signal strength is high enough, but may also be due to other wireless network users with high demands (large downloads etc).

To check signal strength, move the **Stream Xa** close to the source of the wireless network and check performance. If the dropouts stop, then consider a cabled link between the modem/router and the **Stream Xa**.

To check if other network users are restricting the bandwidth, test the **Stream Xa** at a time when there are no other wireless users connected to the network.

NOTE: Lossless and uncompressed files demand more network bandwidth than compressed files. If the music only drops out when listening to these files, this may also indicate inadequate network bandwidth.

SPECIFICATIONS**Power supply**

Voltage As plate on rear of unit

Power consumption

Standby..... <1W

Typical..... 8.5W

EMC & Safety compliance CE

Enclosure

Dimensions (W x H x D) 215 x 75 x 385mm

Weight 3.35kg

Material Die cast chassis

Network connectivity

Cabled Ethernet

Wireless..... 802.11b/g/n

Digital audio performance

USB drive format FAT16, FAT32

Digital Input voltage 500mV pk-pk

Digital Input Impedance 75 Ω

Digital audio formats PCM stereo only

Analogue audio performance

Output (full volume, 0dB FS) 2.0V

S/N ratio (Pre-out, 0dB FS) >105dB

THD+N (Pre-out, 0dB FS) <0.005%

Cyrus reserves the right to change all specifications without notice. E&OE

WARRANTY

The warranty period is two years. No retailer or distributor may vary the terms of this warranty, which is personal to the original Purchaser and is not transferable.

Please retain the sales receipt as proof of purchase.

Warranty claims must wherever possible be made through the Dealer from whom the equipment was purchased.

This warranty excludes:

- Damage caused through neglect, accident, misuse, wear and tear, or through incorrect installation, adjustment or repair by unauthorised personnel. Any unauthorised servicing will result in loss of warranty.
- Liability for damage or loss occurring in transit to or from the purchaser.
- Consequential damage, loss or injury, arising from or in conjunction with this equipment.

Equipment for attention under warranty should be consigned return carriage paid. If returned equipment is found to comply with the published specification, CYRUS reserves the right to raise a charge.

The above conditions do not affect your statutory rights as a consumer.

WEEE

This logo means that this product is not to be disposed of with your household waste. This product should be handed over to a designated collection point to be recycled. Your cooperation in the correct disposal of this product will contribute to the effective usage of natural resources. For more information on collection points, contact your disposal service or City Council.





Cyrus Audio Ltd., Ermine Business Park, Huntingdon, PE29 6XY, U.K.